

# ***Symphony/Symphony-i***

***Advanced User Interface***

***FA800KP/FA850KP***

***FA800KP-i/FA850KP-i***

---

---

***Installation and Setup Guide***



**First  
Alert**  
PROFESSIONAL  
SECURITY SYSTEMS®



# Table of Contents

<b>SECTION 1 General Information</b> .....	<b>1-1</b>
About Symphony/Symphony-i .....	1-1
System Features .....	1-1
Security .....	1-1
Setup .....	1-1
Internet Accessibility .....	1-2
<b>SECTION 2 Mounting and Wiring</b> .....	<b>2-1</b>
Mounting Symphony/Symphony-i.....	2-1
Wiring Symphony/Symphony-i .....	2-2
Phone Line Connections .....	2-3
<b>SECTION 3 Communications Setup</b> .....	<b>3-1</b>
General Information.....	3-1
Network Architecture.....	3-1
Symphony/Symphony-i Connectivity .....	3-1
Typical Residential Broadband Network Methods .....	3-1
Cable Modem Technology Primer .....	3-1
ADSL (Asynchronous Digital Subscriber Line) Primer .....	3-2
<b>SECTION 4 Initial Setup</b> .....	<b>4-1</b>
Initialization .....	4-1
Power Up Symphony/Symphony-i .....	4-1
Setting up an Account Number .....	4-3
Symphony/Symphony-i ECP Addressing .....	4-5
How to Change the ECP Address .....	4-5
How to Enable Additional Symphony/Symphony-i Units in Commercial Controls (FA1660C, FA1700C or equiv)....	4-5
How to Access the Central Station Screen.....	4-10
How to Change the Address on Additional Symphony/Symphony-i Units .....	4-10
How to Select System Options.....	4-13
How to Set the NIGHT Setup Button Function .....	4-13
How to Setup Network Connectivity .....	4-15
How to Setup AlarmNet-i Connectivity.....	4-18
Symphony/Symphony-i Setup .....	4-22
How to Adjust the Touch Screen Contrast.....	4-24
How to Adjust the Volume .....	4-24
How to Select Screen Saver Activation Time.....	4-25
How to Set the Time and Date .....	4-27
<b>SECTION 5 AlarmNet-i Communications Setup</b> .....	<b>5-1</b>
General Information.....	5-1
Enabling AlarmNet-i in the Control Panel.....	5-1
<b>SECTION 6 User Codes</b> .....	<b>6-1</b>
Introduction to User Code Setup.....	6-1
How to Access User Setup.....	6-1
How to Add a User .....	6-3
How to Delete a User .....	6-6
How to Edit a User.....	6-7
<b>SECTION 7 Maintenance</b> .....	<b>7-1</b>
About Symphony/Symphony-i Maintenance .....	7-1
How to Clean Symphony/Symphony-i .....	7-1
Routine Care .....	7-3
<b>SECTION 8 Troubleshooting</b> .....	<b>8-1</b>
Troubleshooting .....	8-1
Diagnostics.....	8-1
About Diagnostics.....	8-1
How to Access the Diagnostics.....	8-1

Performing Diagnostics .....	8-3
LCD Display Test .....	8-3
Real Time Clock Test .....	8-6
Audio Test.....	8-7
LED Test.....	8-8
Keypad Test.....	8-9
Touch Screen Calibration.....	8-10
Symphony/Symphony-i LED Operation.....	8-14
LEDs During Normal (Idle) State.....	8-14
LEDs During Software Downloading.....	8-15
LED Operation When Software Download Fails.....	8-15
<b>SECTION 9 Specifications.....</b>	<b>9-1</b>
Specifications.....	9-1
<b>SECTION 10 Glossary.....</b>	<b>10-1</b>
Glossary .....	10-1

# General Information

---

## In This Section

◆ *About Symphony/Symphony-i*

◆ *System Features*

---

## About Symphony/Symphony-i

Symphony/Symphony-i is an intuitive, graphical touch-screen interface that combines security and home control. Symphony/Symphony-i can be used for:

- Quick and easy security system operation
- Control of the home environment, including the heating and air-conditioning system, lights, garage door, etc.
- Internet alarm reporting (this feature is only included with Symphony-i)

---

**UL**

The home environment control feature has not been evaluated by UL.

---

## System Features

### Security

- Arm System
  - Away
  - Stay
  - Night
- Disarm System
- User Codes - Allows authorized user to add or delete codes
- Bypass Zones

### Setup

- Volume
- Contrast
- Diagnostics
- Keypad Emulation

### **Internet Accessibility**

Selections can be customized for each family member. Typical selections include:

- Event Reminders
- Stock Quotes
- Sports Scores
- Weather
- News Services
- E-Mail Message Displays

# Mounting and Wiring

## In This Section

◆ *Mounting Symphony/Symphony-i*

◆ *Wiring Symphony/Symphony-i*

## Mounting Symphony/Symphony-i

Symphony/Symphony-i should be mounted using the following criteria:

- Symphony/Symphony-i must be mounted **indoors**, and
- Symphony/Symphony-i should be mounted at eye level for easy viewing by the user.

To mount Symphony/Symphony-i, see Figure 1 and complete the following steps:

1. Detach the case back by pushing up into the two tabs located at the bottom of Symphony/Symphony-i with the blade of a screwdriver while pulling the case back and case front apart.
2. Locate the case back over the mounting surface such that the opening in the case back is aligned with the wire/cable access opening (in the mounting surface) while passing the wires/cable through the opening in the case back.
3. Secure the case back to the mounting surface using four screws (supplied).



Prior to attaching the case front to the case back, be sure to wire the Symphony/Symphony-i as described in the "*Wiring Symphony/Symphony-i*" paragraph in this section.

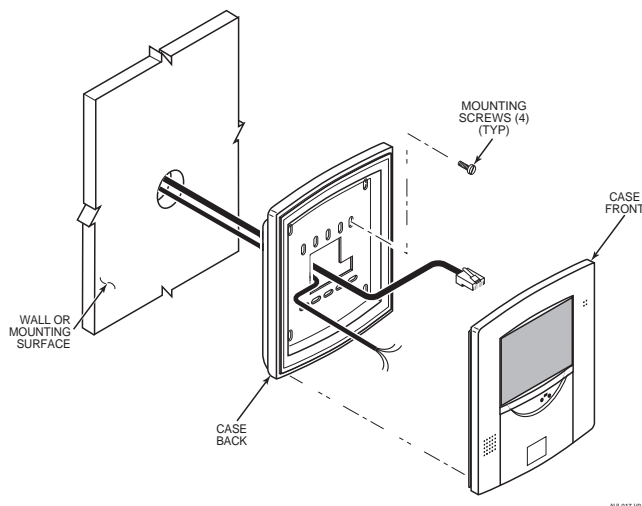

**Figure 1. Mounting Symphony/Symphony-i**

## Wiring Symphony/Symphony-i

Connect Symphony/Symphony-i in parallel with keypads and other peripheral devices using the keypad data (ECP) bus. To wire, see the Summary of Connections diagrams at the back of this guide, or the appropriate Systems Interconnection Diagram provided, and follow the instructions below.

---

**UL**

1. Symphony/Symphony-i must be used in conjunction with a second keypad that is powered by the control panel.
  2. Use a Listed Class 2 power supply suited for the application.
- 



1. Symphony/Symphony-i is provided with either a 6-position or 9-position header connector. Insert wires from the control panel into the Symphony/Symphony-i header connector and secure by placing the header arms in the down position (9-pin connector shown, see Figure 2). When all wires are secured, mount the header on Symphony/Symphony-i by snapping into place.
  2. Unshielded 4-conductor cable is recommended for Symphony/Symphony-i power/data wires. A separate twisted pair cable is recommended for audio bus wires.
- 



High Voltage is present in Symphony/Symphony-i. Extreme care should be used when the back cover is removed.

---

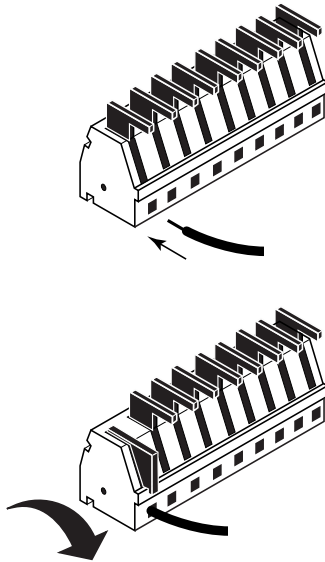

**Figure 2. 9-Pin Header Connector**

**If your unit has a 6-pin connector, connect the wires to the header as follows:**

1. Connect the + terminal of the supplementary power supply to header position 1 (+12VDC terminal of Symphony/Symphony-i (red wire)).
2. Unshielded 4-conductor cable is recommended for Symphony/Symphony-i power/data wires. A separate twisted pair cable is recommended for audio bus wires.
3. Connect the AUX – terminal of the control panel to the (–) terminal of the supplementary power supply (black wire).



4. Connect the (-) terminal of the supplementary power supply to header position 2 (GND terminal of Symphony/Symphony-i (black wire)).
5. Connect the Data In terminal of the control panel to header position 3 (Data Out terminal of Symphony/Symphony-i (green wire)).
6. Connect Data Out terminal of the control panel to header position 4 (Data In terminal of Symphony/Symphony-i (yellow wire)).
7. Connect one end of the Ethernet cable (Category 5) to Symphony/Symphony-i 's RJ45 Ethernet connector and the other end as follows:

<i><b>If using ...</b></i>	<i><b>Then ...</b></i>
broadband (e.g. cable modem, DSL, etc.)	connect to cable/DSL router
narrow band (dial-up modem)	connect to 8950T



You may want to reference cable wiring information for RJ45 cable. For Category 5 cable pin outs, refer to the System Interconnection Diagram supplied.

8. Attach the case front of Symphony/Symphony-i to the case back. Attach the top of Symphony/Symphony-i first, and then press the bottom section inward until it snaps into place securely.

**If using a 9-pin connector, connect the wires to the header as follows:**

1. Connect the (+) terminal of the supplementary power supply to header position 1 (+12VDC terminal of Symphony/Symphony-i (red wire)).
2. Connect the (-) terminal of the supplementary power supply and the Gnd terminal of the control panel to header position 3 (Gnd terminal of Symphony/Symphony-i (black wire)).
3. Connect the +12V terminal of the control panel to header position 2 (+12VDC terminal of Symphony/Symphony-i (red wire)).
4. Connect the Data In terminal of the control panel to header position 4 (Symphony/Symphony-i Data Out terminal (green wire)).
5. Connect the Data Out terminal of the control panel to header position 5 (Symphony/Symphony-i Data In terminal (yellow wire)).
6. Connect the 485 Video bus wires (if video is available and will be used) to header positions 8 and 9 (the audio bus terminals of Symphony/Symphony-i).
7. Connect one end of the Ethernet cable (Category 5) to Symphony/Symphony-i 's RJ45 Ethernet connector and the other end as follows:

<i><b>If using ...</b></i>	<i><b>Then ...</b></i>
broadband (e.g. cable modem, DSL, etc.)	connect to cable/DSL router
narrow band (dial-up modem)	connect to 8950T



You may want to reference cable wiring information for RJ45 cable. For Category 5 cable pin outs, refer to the System Interconnection Diagram supplied.

8. Attach the case front of Symphony/Symphony-i to the case back. Attach the top of Symphony/Symphony-i first, and then press the bottom section inward until it snaps into place securely.

## Phone Line Connections

Use a standard RJ31X phone jack (CA38A in Canada) and direct-connect cord, and wire as shown in the System Interconnection Diagram supplied.

# Communications Setup

## In This Section

- ◆ *General Information*
- ◆ *Network Architecture*
- ◆ *Symphony/Symphony-i Connectivity*
- ◆ *Typical Residential Broadband Network Methods*
- ◆ *Cable Modem Technology Primer*
- ◆ *ADSL (Asynchronous Digital Subscriber Line) Primer*

## General Information

This section provides an overview of networking techniques and methods commonly used in home and commercial Local Area Networks (LANs). While no single method described here may apply to your specific Symphony/Symphony-i installation, the information should serve as a framework for increasing your general understanding of data network applications.

### Network Architecture

This overview describes several typical LAN configurations:

- Cable Modem (DOCSIS)
- ADSL (Advanced Digital Subscriber Line)

### Symphony/Symphony-i Connectivity

The Symphony/Symphony-i family connects to any of these network variants in the same manner; via an Ethernet cable (10BaseT), terminating in an RJ45 connector. Although Symphony/Symphony-i provides its own security and does not require a firewall, it is recommended that in most installations, Symphony/Symphony-i be connected through a Firewall/Router device, which will enable the device to be connected to the home network without altering the connections of any other device on the network.

## Typical Residential Broadband Network Methods

There are two typical “broadband” (high data rate) networking solutions available to the U.S. residential market: Cable Modem and ADSL. Currently, Cable Modem technology has the largest number of residential subscribers, since ADSL has certain range limitations that do not affect fiber optic/coaxial cable networks. This section provides some background information on the technologies themselves.

### Cable Modem Technology Primer

Cable systems were originally designed to deliver broadcast television signals efficiently to subscribers' homes. To ensure that consumers could obtain cable service with the same TV sets they use to receive over-the-air broadcast TV signals, cable operators recreate a portion of the over-the-air radio frequency (RF) spectrum within a sealed coaxial cable line.

Traditional coaxial cable systems typically operate with 330 MHz or 450 MHz of capacity, whereas modern hybrid fiber/coax (HFC) systems are expanded to 750 MHz or more.

Logically, downstream video programming signals begin around 50 MHz, the equivalent of channel 2 for over-the-air television signals. The 5 MHz - 42 MHz portion of the spectrum is usually reserved for upstream communications from subscribers' homes.

Each standard television channel occupies 6 MHz of RF spectrum. Thus a traditional cable system with 400 MHz of downstream bandwidth can carry the equivalent of 60 analog TV channels and a modern HFC system with 700 MHz of downstream bandwidth has the capacity for some 110 channels.

To deliver data services over a cable network, one television channel (in the 50 - 750 MHz range) is typically allocated for downstream traffic to homes and another channel (in the 5 - 42 MHz band) is used to carry upstream signals.

A headend cable modem termination system (CMTS) communicates through these channels with cable modems located in subscriber homes to create a virtual local area network (LAN) connection. Most cable modems are external devices that connect to a personal computer (PC) through a standard 10Base-T Ethernet card or Universal Serial Bus (USB) connection, although internal PCI modem cards are also available.

The cable modem access network operates at Layer 1 (physical) and Layer 2 (media access control/logical link control) of the Open System Interconnect (OSI) Reference Model. Thus, Layer 3 (network) protocols, such as IP traffic, can be seamlessly delivered over the cable modem platform to end users.

A single downstream 6 MHz television channel may support up to 27 Mbps of downstream data throughput from the cable headend using 64 QAM (quadrature amplitude modulation) transmission technology. Speeds can be boosted to 36 Mbps using 256 QAM. Upstream channels may deliver 500 kbps to 10 Mbps from homes using 16QAM or QPSK (quadrature phase shift key) modulation techniques, depending on the amount of spectrum allocated for service. This upstream and downstream bandwidth is shared by the active data subscribers connected to a given cable network segment, typically 500 to 2,000 homes on a modern HFC network.

An individual cable modem subscriber may experience access speeds from 500 kbps to 1.5 Mbps or more (depending on the network architecture and traffic load); blazing performance compared to dial-up alternatives. However, when surfing the Web, performance can be affected by Internet backbone congestion.

In addition to speed, cable modems offer another key benefit: constant connectivity. Because cable modems use connectionless technology, much like in an office LAN, a subscriber's PC is always online with the network. That means there's no need to dial-in to begin a session, so users do not have to worry about receiving busy signals. Additionally, going online does not tie up their telephone line, which (in the case of) is very important in an emergency reporting situation.

### **ADSL (Asynchronous Digital Subscriber Line) Primer**

Asymmetric Digital Subscriber Line (ADSL) is a competing modem technology that converts existing twisted-pair telephone lines into access paths for multimedia and high-speed data communications. ADSL can transmit up to 6 Mbps to a subscriber, and as much as 832 kbps or more in both directions.

An ADSL circuit connects an ADSL modem on each end of a twisted-pair telephone line, creating three information channels -- a high-speed downstream channel, a medium speed duplex channel, depending on the implementation of the ADSL architecture, and a POTS (Plain Old Telephone Service) or an ISDN channel. The POTS/ISDN channel is split off from the digital modem by filters, thus guaranteeing uninterrupted POTS/ISDN, even if ADSL

fails. The high-speed channel ranges from 1.5 to 6.1 Mbps, while duplex rates range from 16 to 832 kbps. Each channel can be sub-multiplexed to form multiple, lower rate channels, depending on the system.

ADSL modems provide data rates consistent with North American and European digital hierarchies and can be purchased with various speed ranges and capabilities. The minimum configuration provides 1.5 or 2.0 Mbps downstream and a 16-kbps duplex channel; others provide rates of 6.1 Mbps and 64 kbps duplex. Products with downstream rates up to 8 Mbps and duplex rates up to 640 kbps are available today. ADSL modems will accommodate ATM transport with variable rates and compensation for ATM overhead, as well as IP protocols.

Downstream data rates depend on a number of factors, including the length of the copper line, its wire gauge, presence of bridged taps, and cross-coupled interference. Line attenuation increases with line length and frequency, and decreases as wire diameter increases.



# Initial Setup



**In This Section**



- ◆ Initialization
- ◆ Setting up an Account Number
- ◆ Symphony/Symphony-i ECP Addressing
- ◆ How to Change the ECP Address
- ◆ How to Select the System Options
- ◆ How to Set the Night Setup Button Function
- ◆ How to Set Network Connectivity
- ◆ How to Setup Network Services
- ◆ Symphony/Symphony-i Setup
- ◆ How to Adjust the Touch Screen Contrast
- ◆ How to Adjust the Volume
- ◆ How to Select Screen Saver Activation Time
- ◆ How to Set the Time and Date

**Initialization**

**Power Up Symphony/Symphony-i**

When initially powered, the screen displays the boot sequence as it is performed. After it is determined what services are available, the screen displays the Touch Screen Calibration screen. Calibrate the touch screen as follows:



SCREEN	ACTION
 <p style="text-align: center;"><b>Touch Screen Calibration</b> Touch the center of the square displayed in the corner.</p>	<p>1. Within the Touch Screen Calibration screen you are asked to "Touch the center of the square displayed in the corner." Press the center of the square.</p> <p>When this square is touched the <b>Touch Screen Calibration</b> screen displays "<b>Next Point.. Touch the center of the square.</b>"</p>
 <p style="text-align: center;"><b>Touch Screen Calibration</b> No Touch Detected.. Try Again.</p>	<p><b>NOTE:</b> If no touch is made within 5 seconds, "<b>No Touch Detected.. Try Again.</b>" is displayed in the center of the <b>Touch Screen Calibration</b> screen.</p>

SCREEN	ACTION
<p style="text-align: center;"><b>Touch Screen Calibration</b> Next Point .. Touch the center of the square</p> 	<p>2. Press the center of the square. The <b>Touch Screen Calibration</b> screen displays "Verifying Calibration.. Touch the center of the square."</p>
<p style="text-align: center;"><b>Touch Screen Calibration</b> No Touch Detected.. Try Again.</p> 	<p><b>NOTE:</b> If no touch is made within 5 seconds, "No Touch Detected.. Try Again." is displayed in the center of the <b>Touch Screen Calibration</b> screen.</p>
<p style="text-align: center;"><b>Touch Screen Calibration</b> Verifying Calibration .. Touch the center of the square</p> 	<p>3. Press the center of the square. If touch screen calibration was successful, "<b>CALIBRATION SUCCESSFUL</b>" is displayed momentarily. You are then returned automatically to boot screen.</p>
<p style="text-align: center;"><b>Touch Screen Calibration</b> CALIBRATION SUCCESSFUL.</p>	<p>If touch screen calibration was not successful, "<b>Calibration Unsuccessful</b>" is displayed momentarily. You are then returned automatically to the first <b>Touch Screen Calibration</b> screen.</p> <p><b>NOTE:</b> You will progress through the <b>Touch Screen Calibration</b> screens regardless of where you touch. To successfully calibrate the touch screen you must press the center of the box on each screen.</p>

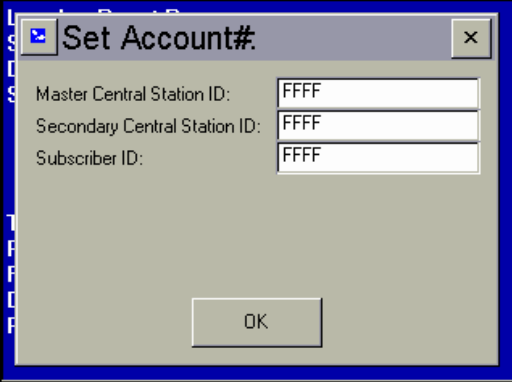

## Setting up an Account Number

After the touch screen has been calibrated, the boot process will continue until the **Set Account #** window is displayed. This account number is required for Internet content and remote control. It is not required for code update. Set the account number as follows:

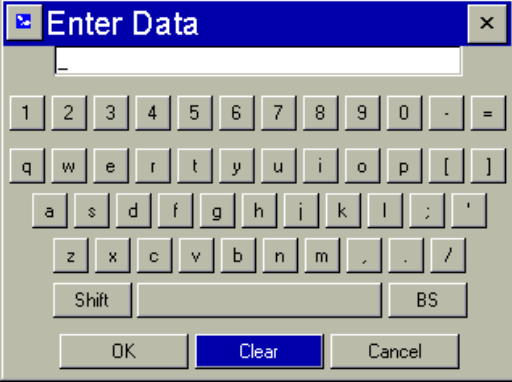
SCREEN	ACTION
 	<p>1. Press the box next to the Master Central Station ID. The Enter Data keyboard is displayed.</p> <p><b>NOTE:</b> The Central Station IDs are provided by the Central Station or by AlarmNet.</p>
	<p>2. Press the <b>Clear</b> button to delete any previous account information (typically set to FFFF from the manufacturer). The text box at the top of the <b>Enter Data</b> keyboard is cleared with the cursor in the first position.</p>

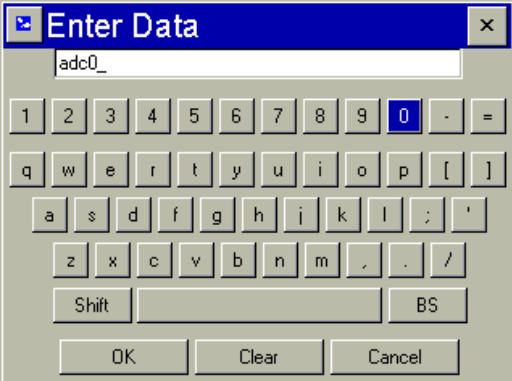
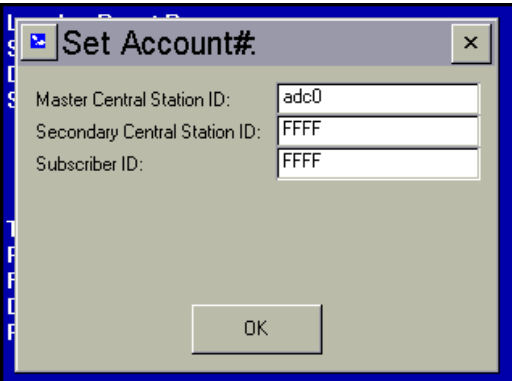
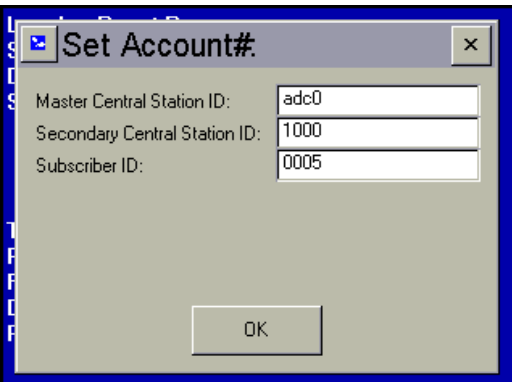
SCREEN	ACTION
	<p>3. Enter the 4-digit alphanumeric <b>Master Central Station ID</b> for this account.</p>
	<p>4. Press the <b>OK</b> button. You are returned to the <b>Set Account#:</b> window with the <b>Master Central Station ID</b> displayed.</p>
	<p>5. Repeat steps 1 through 4 for the <b>Secondary Central Station ID</b> and <b>Subscriber ID</b> boxes. When the entire 12-digit account number has been entered, press the <b>OK</b> button on the <b>Set Account#</b> window.</p> <p>You are then returned automatically to the boot screen.</p>

## Symphony/Symphony-i ECP Addressing

After the Account Number has been set, the boot process will continue until the **Set ECP Address** window is displayed.

SCREEN	ACTION
	<p>If the system is incorporating only one Symphony/Symphony-i, leave the address set to 1 and press the <b>OK</b> button. The boot-up process will continue until completion.</p> <p>If there are to be additional Symphony/Symphony-i units in the system, refer to the <i>How to Change the ECP Address</i> paragraph.</p>



### How to Change the ECP Address

When the system contains two or more Symphony/Symphony-i units, it will be necessary to assign a different ECP address to each unit. **On residential control panels (FA168CPS or equivalent)**, two units may be used (addresses 1 and 2). These are automatically enabled in the control panel.

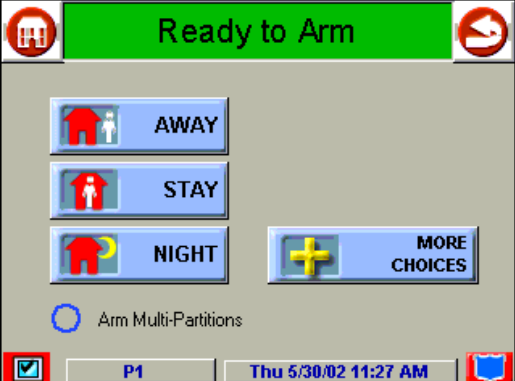

**On commercial control panels (FA1660C, FA1700C or equivalent)**, up to six units may be used, (addressed between 1-6). Address 1 is automatically enabled in the control panel. Additional units will be inoperable until each address is enabled in the control panel's "Device Programming" mode. You can enable additional addresses in the control panel using the unit set to address 1.

### How to Enable Additional Symphony/Symphony-i Units in Commercial Controls (FA1660C, FA1700C or equiv)

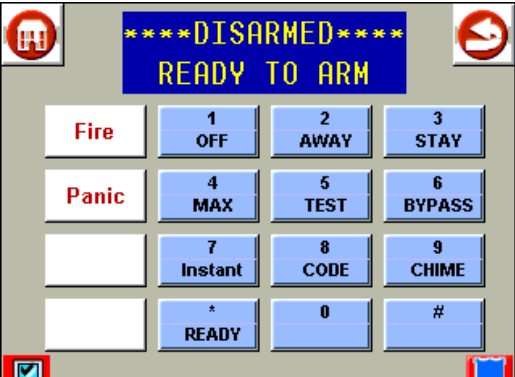
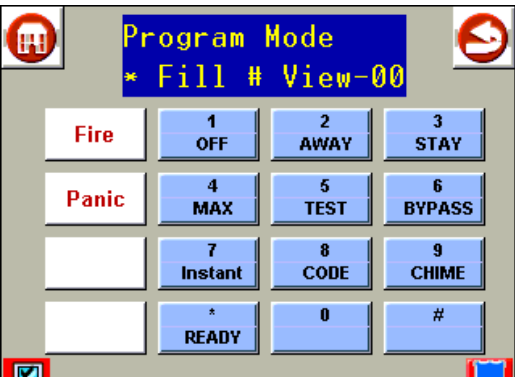
SCREEN	ACTION
	<ol style="list-style-type: none"> <li>1. Press the <b>SECURITY</b> button on the "Home" screen. The "Arming" screen is displayed.</li> </ol>

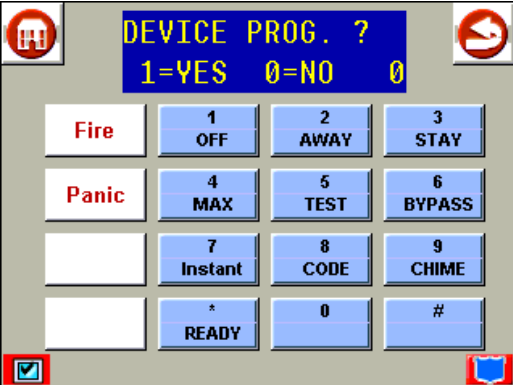
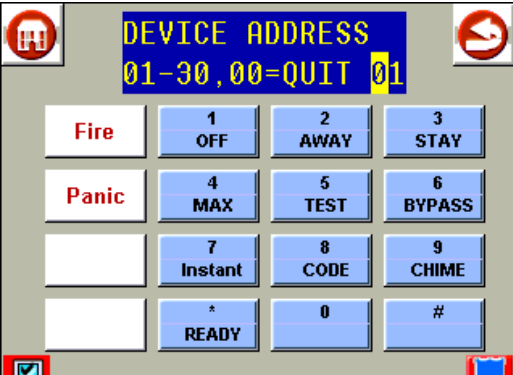
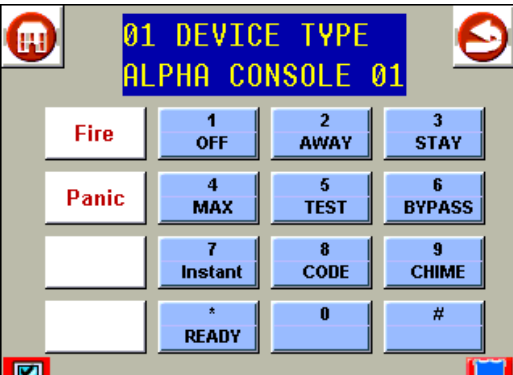
SCREEN	ACTION
 <p>The screenshot shows a green header bar with "Ready to Arm" in white text. Below the header are four buttons: "AWAY" (with a house icon), "STAY" (with a person icon), "NIGHT" (with a house and moon icon), and "MORE CHOICES" (with a plus sign icon). At the bottom, there is a status bar with "P1" and "Thu 5/30/02 11:27 AM".</p>	<p>2. Press the <b>MORE CHOICES</b> button. The "More Choices" screen is displayed.</p>
 <p>The screenshot shows a green header bar with "Ready to Arm" in white text. Below the header are six buttons: "SHOW ZONES" (with a target icon), "CONSOLE MODE" (with a keypad icon), "EVENT LOGS" (with a document icon), "OPERATING MODES" (with a gear icon), "REFRESH WEB" (with a refresh icon), and "SETUP" (with a question mark icon). At the bottom, there is a status bar with "P1" and "Thu 5/30/02 9:31 AM".</p>	<p>3. Press the <b>CONSOLE MODE</b> button. The "Keypad" screen appears.</p>
 <p>The screenshot shows a blue header bar with "****DISARMED****" and "READY TO ARM" in yellow text. Below the header is a keypad with buttons for "Fire", "Panic", and numbers 1-9, *, 0, #. The buttons are labeled: 1 OFF, 2 AWAY, 3 STAY, 4 MAX, 5 TEST, 6 BYPASS, 7 Instant, 8 CODE, 9 CHIME, * READY, 0, #.</p>	<p>4. Enter the Data Field Programming Mode by entering the 4-digit <b>installer code + 8 + 000</b>. The <b>Program Mode</b> screen is displayed.</p>
 <p>The screenshot shows a blue header bar with "Program Mode" and "* Fill # View-00" in yellow text. Below the header is a keypad with buttons for "Fire", "Panic", and numbers 1-9, *, 0, #. The buttons are labeled: 1 OFF, 2 AWAY, 3 STAY, 4 MAX, 5 TEST, 6 BYPASS, 7 Instant, 8 CODE, 9 CHIME, * READY, 0, #.</p>	<p>5. Press <b>#93</b> to display the <b>ZONE PROG. ?</b> screen.</p>

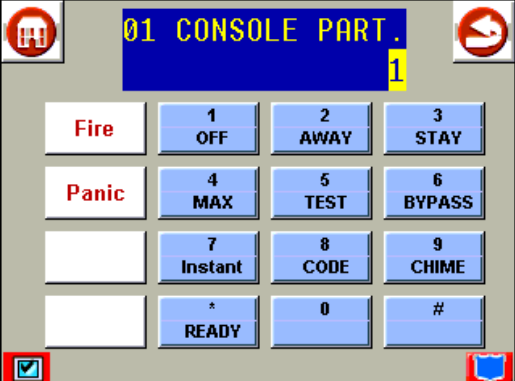
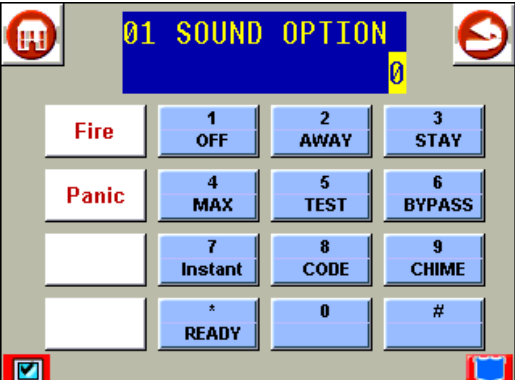
SCREEN	ACTION
	<p>6. Press <b>0</b> repeatedly until the <b>DEVICE PROG. ?</b> screen is displayed.</p>
	<p>7. Press <b>1</b> to enter <i>Device Programming</i>. The <b>DEVICE ADDRESS</b> screen is displayed.</p>
	<p>8. Enter the 2-digit Symphony/Symphony-i ECP address to match the address you will set the additional unit for (<b>01-06</b>). The address identifies the Symphony/Symphony-i to the control.</p> <p><b>NOTE:</b> Device Address 01 is defaulted for an AUI (Symphony/Symphony-i) with Keypad Global arm/disarm enabled.</p> <p>Press [ * ] to accept entry. The <b>DEVICE TYPE</b> screen is displayed.</p>
	<p>9. Select the type of addressable device as <b>01</b> (Alpha Console).</p> <p>Press [ * ] to accept entry. The <b>CONSOLE PART</b> screen is displayed.</p>

SCREEN	ACTION
	<p>10. Enter the Symphony/Symphony-i 's default partition number (1 to maximum number of partitions programmed for system in field 2*00). This is the primary partition for which the Symphony/Symphony-i will be used. Enter <b>9</b> to make this Symphony/Symphony-i a "Master" keypad for the system.</p> <p>Press [ * ] to accept entry. The <b>SOUND OPTION</b> screen is displayed.</p>
	<p>11. Keypads can be individually programmed to suppress arm/disarm beeps, entry/exit beeps and chime mode beeps. This helps prevent unwanted sounds from disturbing users in certain areas of the premises.</p> <p>Enter a number <b>0-3</b> for the keypad sounding suppression options desired for the keypad as follows:</p> <ul style="list-style-type: none"> <li><b>0</b> = no suppression.</li> <li><b>1</b> = suppress arm/disarm &amp; entry/exit beeps.</li> <li><b>2</b> = suppress chime mode beeps only.</li> <li><b>3</b> = suppress arm/disarm, entry/exit, and chime mode beeps.</li> </ul> <p>Press [ * ] to accept entry.</p> <p>The <b>KEYPAD GLOBAL</b> screen is displayed.</p>
	<p>12. Each keypad can give users with access to multiple partitions the ability to arm and disarm those partitions from it. To enable this keypad for global arming/disarming, enter <b>1</b>. To prevent the ability to use this keypad for global arming/disarming, enter <b>0</b>.</p> <p>Press [ * ] to accept entry.</p> <p>The <b>AUI ?</b> screen is displayed.</p>

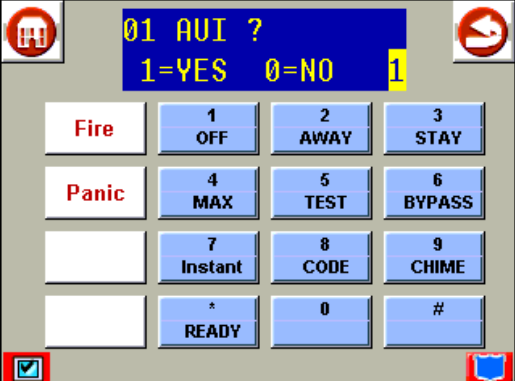
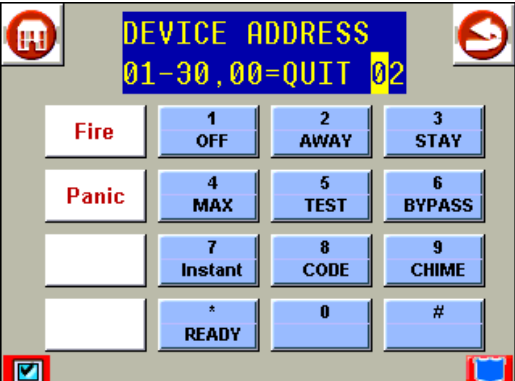
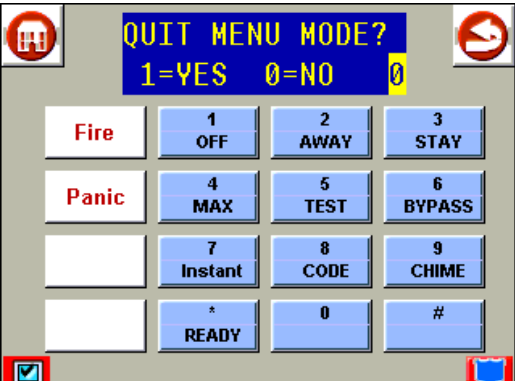
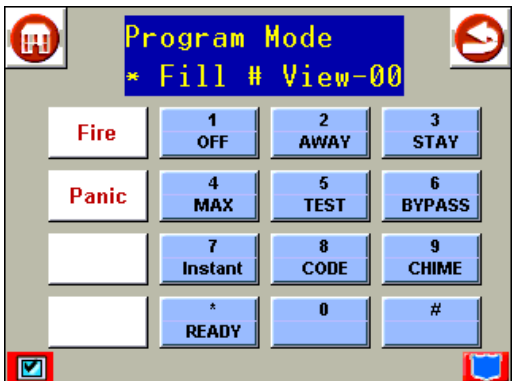

SCREEN	ACTION
	<p>13. Enter <b>1</b> (YES) to identify this device as an AUI (Symphony/Symphony-i). The screen will prompt for the next Device Address to be programmed.</p>
	<p>14. Enter the next address to be programmed to enable another ECP device. When Finished, enter <b>00</b>, then <b>*</b>. The <b>QUIT MENU MODE?</b> screen is displayed.</p>
	<p>15. Enter <b>1</b>. The Program Mode screen is displayed.</p>
	<p>16. From this screen you can enter <b>* 99</b> to return to the Console Mode screen.</p> <p>NOTE: When programming mode is exited, Symphony/Symphony-i will reset within 2 minutes. If Symphony/Symphony-i is being used with an FA168CPS or equivalent control panel, it will immediately reset.</p>

### How to Change the Address on Additional Symphony/Symphony-i Units

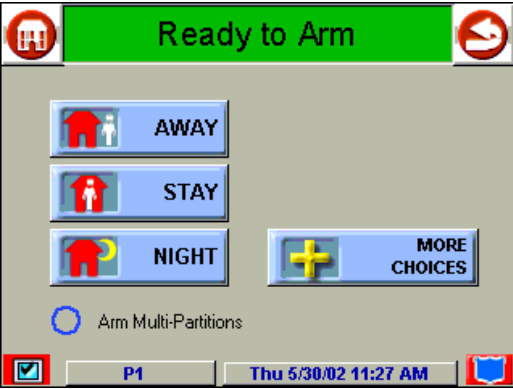

After enabling additional addresses in the control panel using the Symphony/Symphony-i set to address 1, power up each additional Symphony/Symphony-i one at a time, and set its address to one of the addresses you enabled in the control panel. If this is a first time power-up of the unit, follow the initialization procedure in Section 4. Otherwise, access the Central Station screen, then follow the procedure to change the address on the unit.

### How to Access the Central Station Screen

To Access the “Central Station” screen perform the following:

SCREEN	ACTION
	<p>1. Press the <b>SECURITY</b> button on the “Home” screen. The “Arming” screen is displayed.</p>
	<p>2. Press the <b>MORE CHOICES</b> button. The “More Choices” screen is displayed.</p>
	<p>3. Press the <b>SETUP</b> button on the “More Choices” screen. The “Setup” screen is displayed.</p>

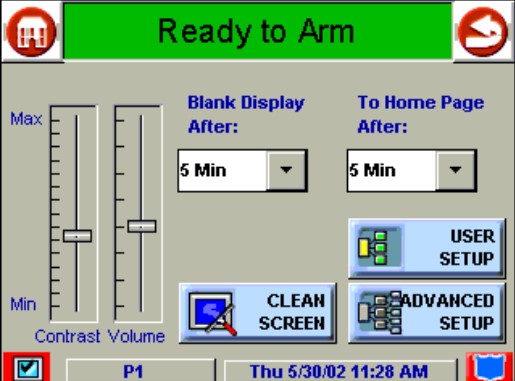

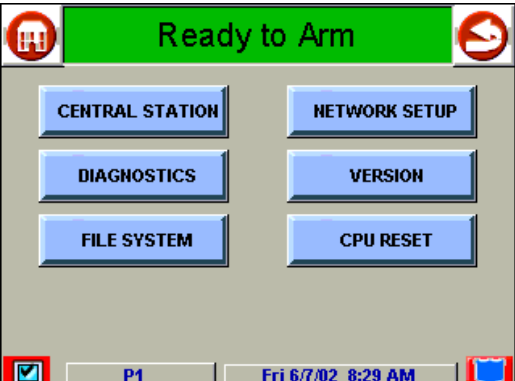
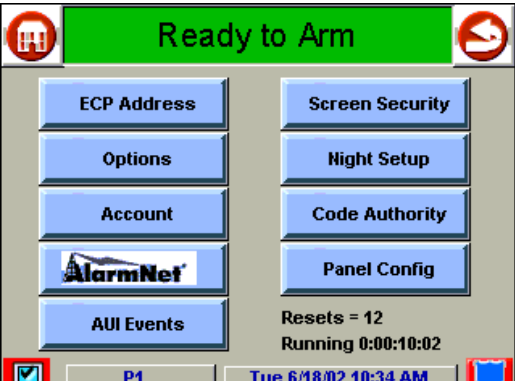

SCREEN	ACTION
	<p>4. Press the <b>ADVANCED SETUP</b> button. The <b>Enter Authorized Code:</b> authorization screen is displayed.</p>
	<p>5. Enter your 4-digit Installer code. The "Advanced Setup" menu screen is displayed.</p>
	<p>6. Press the <b>Central Station</b> button. The "Central Station" menu screen is displayed.</p>
	

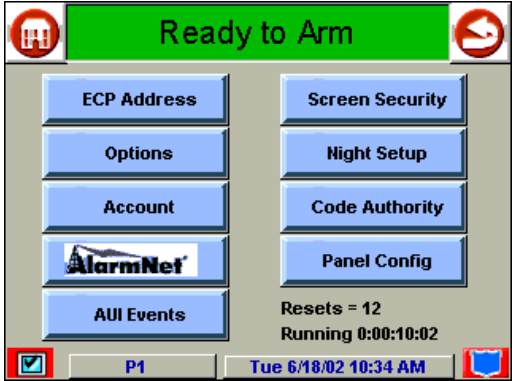
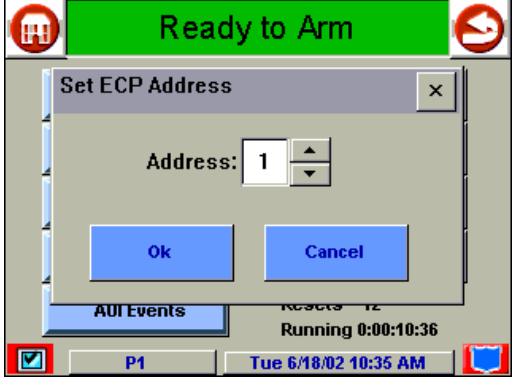
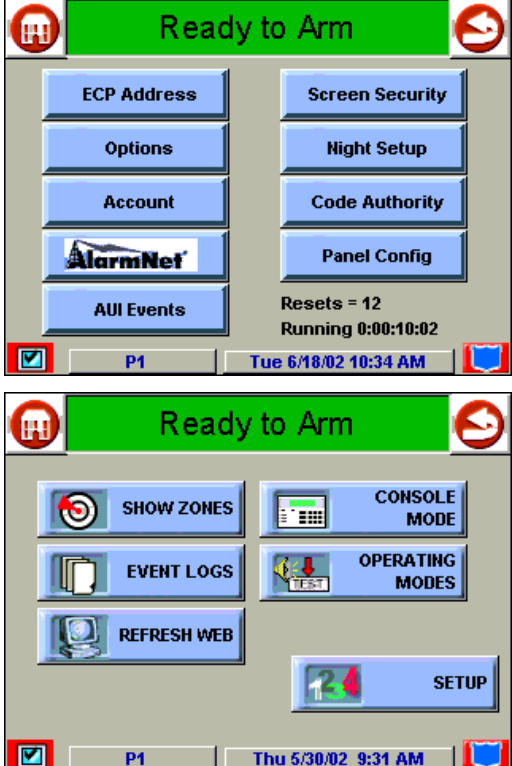
To change the address, perform the following.

SCREEN	ACTION
	<p>1. On the "Central Station" screen press the ECP Address button. A pop-up window is displayed with options for selecting Symphony/Symphony-i's ECP address.</p>
	<p>2. The available ECP addresses are 1-6 for commercial controls (e.g., FA1660C) and 1-2 for residential controls (e.g., FA168CPS). Select the ECP address for this Symphony/Symphony-i using the Up/Dn arrows. Press the <b>OK</b> button to accept the address setting or the <b>CANCEL</b> button to maintain the original ECP address. Symphony/Symphony-i goes to the "Central Station" menu screen.</p>
	<p>3. Press the "Back" icon <u>twice</u> to save the new address. The "More Choices" screen is displayed.</p>

### How to Select System Options

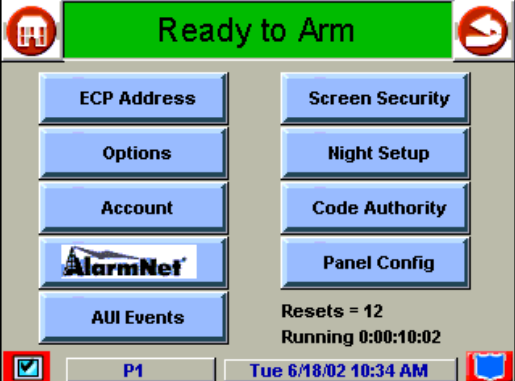
The system options allow you to place buttons on the "Home" screen. The **SECURITY** button is always displayed and cannot be removed. Buttons that can be added are Lighting, Heating/Cooling (DEMO only), and Video (DEMO only). To avoid confusion to the user, only buttons whose options are functional in the system should be displayed. To select the system options, do the following:

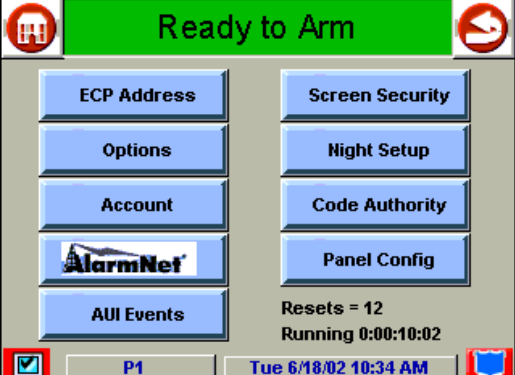
SCREEN	ACTION
	<p>1. On the "Central Station" screen press the <b>Options</b> button. A pop-up window is displayed with options for selecting <b>Lighting</b> and/or <b>Internet</b>.</p>
	<p>2. Select the options that the system will have. For example, select Lighting if the system will have the lighting function installed. Select all, none, or any combination of options.</p> <p><b>NOTE: Heating/Cooling and Video</b> are provided for demonstration purposes only.</p> <p>Press the <b>DONE</b> button to accept the setting. Symphony/Symphony-i returns to the "Central Station" menu screen.</p>
	

### How to Set the NIGHT Setup Button Function

The NIGHT button can be set to arm the system in one of four arming modes:

- Away - When selected, arms all zones with entry delay.
- Stay - When selected, arms perimeter zones with entry delay.
- Instant - When selected, arms perimeter zones without entry delay.
- Maximum - When selected, arms all zones without entry delay.

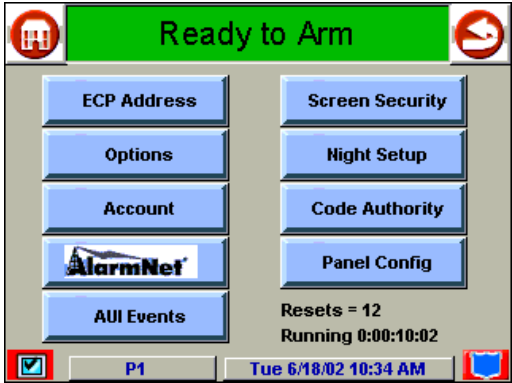
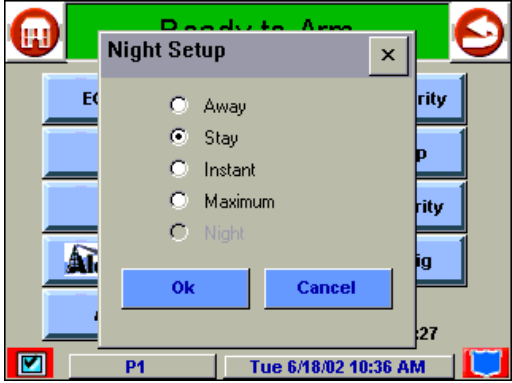
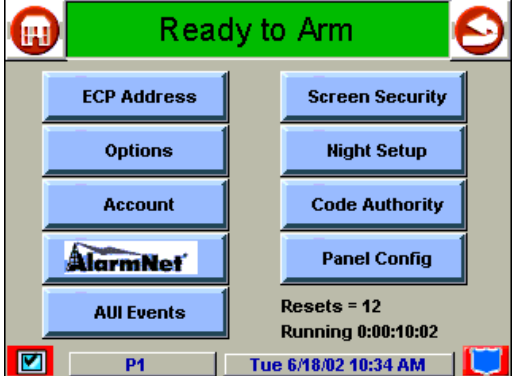

To set the NIGHT button function, do the following:

SCREEN	ACTION
	<p>1. On the "Central Station: screen press the <b>Night Setup</b> button. A Night Setup: pop-up window is displayed with options for selecting Away, Stay, Instant, and Maximum.</p>
	<p>2. Select the arming mode that will be activated by pressing the <b>NIGHT</b> button on the "Arming" screen. Press the <b>Ok</b> button to accept the setting, or press the <b>Cancel</b> button to cancel your selection. In either case Symphony/Symphony-i goes to the "Central Station" menu screen.</p>
	

### How to Setup Network Connectivity

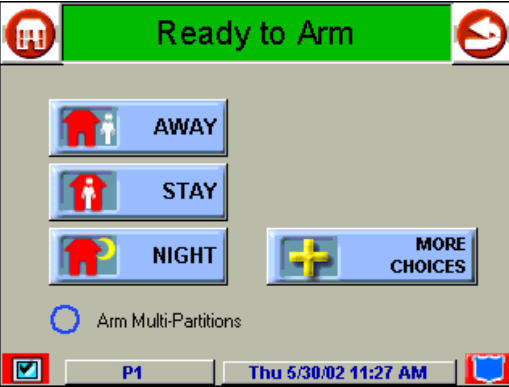
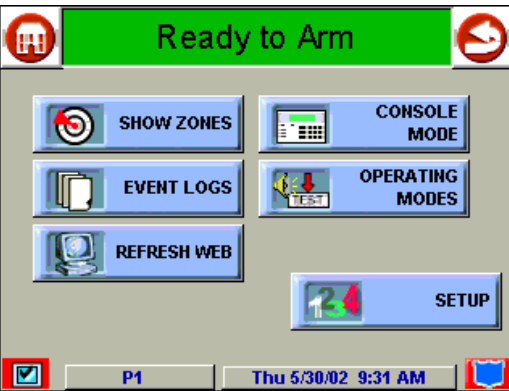
Depending on your network connection choice, you may or may not need to set the network connectivity. Symphony/Symphony-i is defaulted to the Ethernet connection with DHCP also selected. If you have selected another network connection option, set the network connectivity as follows:

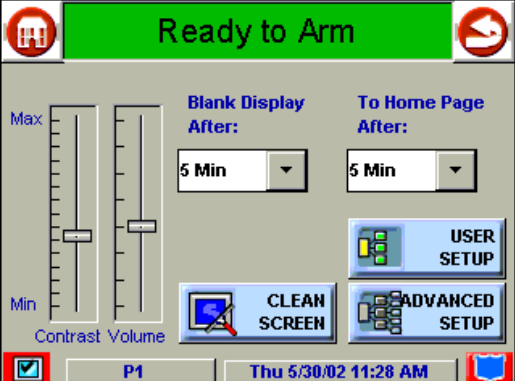
SCREEN	ACTION
	<p>1. From the "Home" screen, press the <b>SECURITY</b> button. The "Arming" screen is displayed.</p>
	<p>2. Press the <b>MORE CHOICES</b> button. The "More Choices" screen is displayed.</p>
	<p>3. Press the <b>SETUP</b> button. The "Setup" screen is displayed.</p>

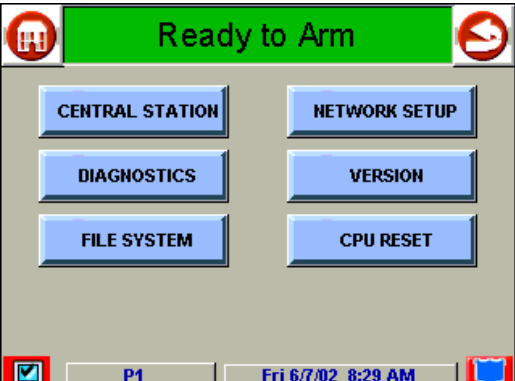
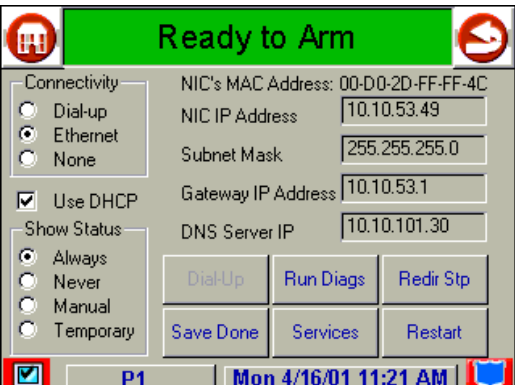
SCREEN	ACTION
	<p>4. Press the <b>ADVANCED SETUP</b> button. The <b>Enter Authorized Code:</b> authorization screen is displayed.</p>
	<p>5. Enter your 4-digit Installer code. The "Advanced Setup" menu screen is displayed.</p>
	<p>6. Press the <b>Network Setup</b> button. The "Network Setup" screen is displayed.</p>
	<p>7. If you are using a dial-up modem press the circle next to <b>Dial-up</b>. The "Dial-up" screen is displayed with the previously "ghosted" <b>Dial-Up</b> button now displayed and <b>Use DHCP</b> now "ghosted".</p> <p>If you are using Ethernet (cable modem or DSL), press the circle next to <b>Ethernet</b>.</p>

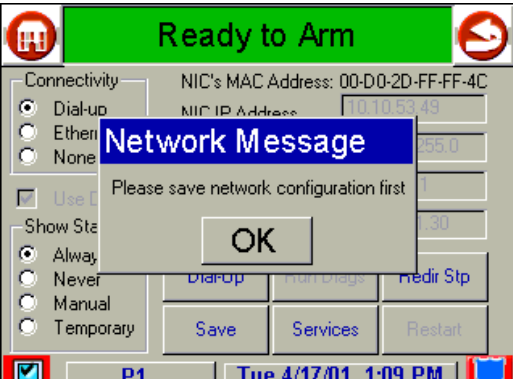
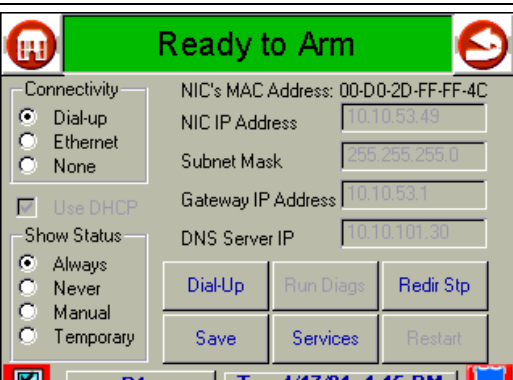
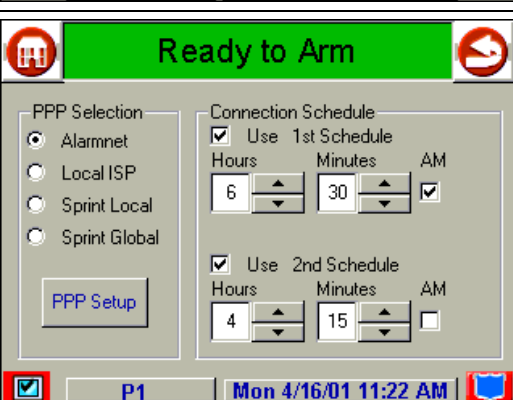
SCREEN	ACTION
	<p>8. The <b>Network Message</b> pop-up window is displayed with the message <b>Please save network configuration first</b>.</p>
	<p>9. Press the <b>OK</b> button. The "Dial-up" or "Ethernet" screen (whichever is appropriate) is again displayed.</p> <p><b>NOTE: If you are using Dial-up and are connecting to a PABX line, go to step 10. If not, perform step 12. Refer to the <i>About Using a PABX Line</i> paragraph below for important information.</b></p>
	<p>10. Press the <b>Dial-Up</b> button. The "Dial-Up Setup" screen is displayed.</p>
	<p>11. Press the PPP Setup button. The PPP Login Information screen is displayed.</p>

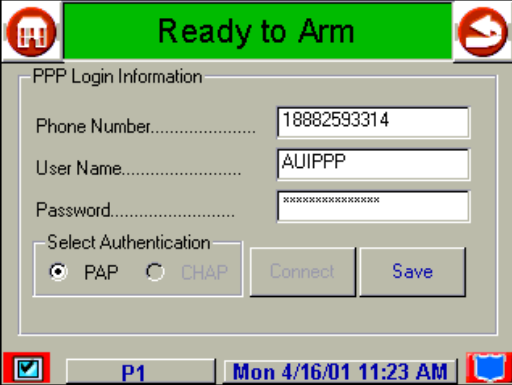
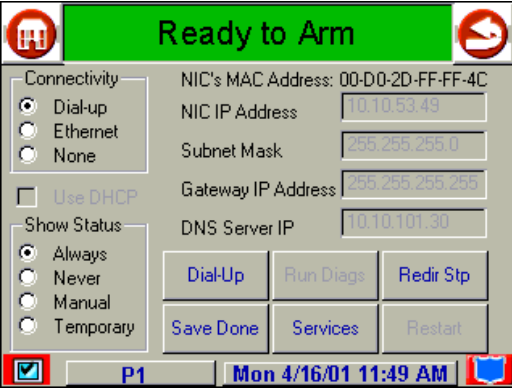



SCREEN	ACTION
	<p>12. Record the Phone Number displayed.</p> <p>Press the box in which the phone number is displayed. A data entry screen appears.</p> <p>Enter [ 9 ] + [ , ] + the recorded phone number. Press OK on the data entry screen, then press the Save button on the PPP Login Information screen.</p> <p>Press the <b>Save</b> button. The configuration is saved and the <b>Save</b> button changes to <b>Save Done</b>. Restart the system.</p>
	



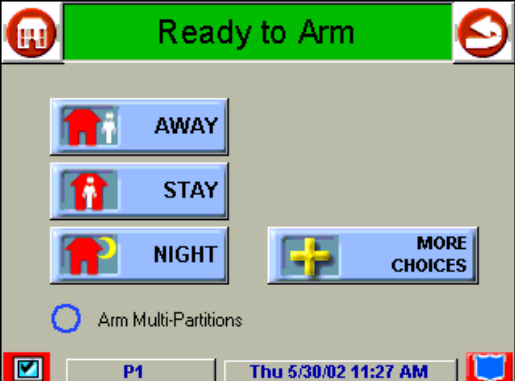

### How to Setup AlarmNet-i Connectivity

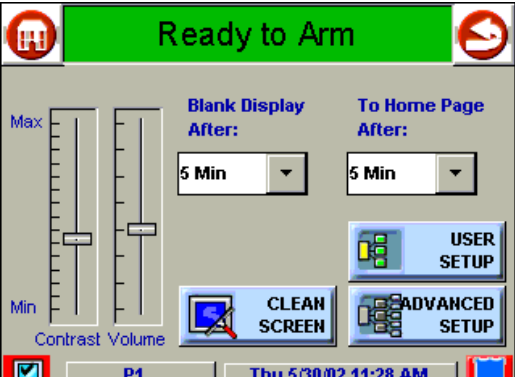

AlarmNet-i is an available option. Set up Symphony/Symphony-i for AlarmNet-i, following the steps below. Note that the Symphony/Symphony-i connectivity parameter must be set to Ethernet. AlarmNet-i is not supported using dial-up.

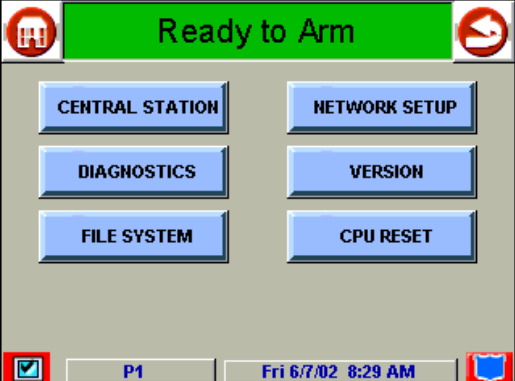

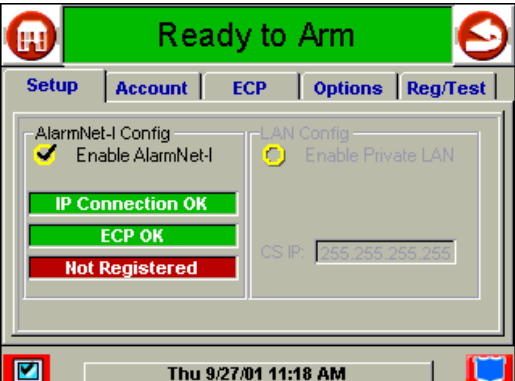
SCREEN	ACTION
	<p>1. From the "Home" screen, press the <b>SECURITY</b> button. The "Arming" screen is displayed.</p>



SCREEN	ACTION
 <p>The screenshot shows the 'Ready to Arm' screen with a green header. Below the header are four buttons: 'AWAY' (with a house icon), 'STAY' (with a house and person icon), 'NIGHT' (with a house and moon icon), and 'MORE CHOICES' (with a plus sign icon). At the bottom, there is a status bar with a checkmark, 'P1', 'Thu 5/30/02 11:27 AM', and a book icon.</p>	<p>2. Press the <b>MORE CHOICES</b> button. The "More Choices" screen is displayed.</p>
 <p>The screenshot shows the 'Ready to Arm' screen with a green header. Below the header are several menu options: 'SHOW ZONES', 'EVENT LOGS', 'REFRESH WEB', 'CONSOLE MODE', 'OPERATING MODES', and 'SETUP' (with a question mark icon). At the bottom, there is a status bar with a checkmark, 'P1', 'Thu 5/30/02 9:31 AM', and a book icon.</p>	<p>3. Press the <b>SETUP</b> button. The "Setup" screen is displayed.</p>
 <p>The screenshot shows the 'Ready to Arm' screen with a green header. Below the header are two sliders for 'Contrast' and 'Volume', and two dropdown menus for 'Blank Display After' and 'To Home Page After', both set to '5 Min'. There are also buttons for 'CLEAN SCREEN', 'USER SETUP', and 'ADVANCED SETUP'. At the bottom, there is a status bar with a checkmark, 'P1', 'Thu 5/30/02 11:28 AM', and a book icon.</p>	<p>4. Press the <b>ADVANCED SETUP</b> button. The <b>Enter Authorized Code:</b> authorization screen is displayed.</p>
 <p>The screenshot shows the 'Enter Authorized Code' screen with a green header. Below the header is a numeric keypad with buttons for digits 1-9, 0, and a 'CLEAR' button. A yellow box on the right contains the text 'Enter Authorized Code:'. At the bottom, there is a status bar with a checkmark, 'P1', 'Wed 6/5/02 11:21 AM', and a book icon.</p>	<p>5. Enter your 4-digit Installer code. The "Advanced Setup" menu screen is displayed.</p>

SCREEN	ACTION
	<p>6. Press the Central Station button. The "Central Station Setup" screen is displayed.</p>
	<p>7. Press the AlarmNet button. The AlarmNet-i setup screen is displayed.</p>
	<p>8. Check the doughnut to enable <b>AlarmNet-i</b>. Press <b>Account</b> tab to continue.</p>
	<p>9. AlarmNet-i uses the Symphony/Symphony-i <b>Master Account #</b> as the default AlarmNet account. To enter a different <b>Primary Account #</b>, un-check the doughnut. Secondary CS reporting can be enabled by checking the doughnut and entering <b>Secondary Account</b> information. Press the <b>ECP</b> tab to continue.</p>

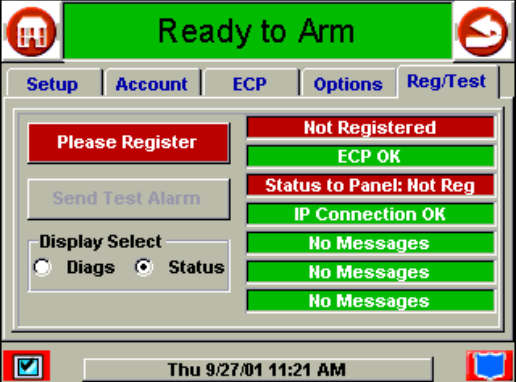
SCREEN	ACTION
	<p>10. Select the AlarmNet-i ECP Address. Use the same address that was entered during panel programming in the How to Enable <i>Additional Symphony/Symphony-i Units in Commercial Control</i> paragraph, step 14 in this Section.</p> <p><b>NOTE:</b> The AlarmNet-i address will be different than the Symphony/Symphony-i ECP address. Select Device Reporting Priority as Stand Alone or Secondary. This selection sets the device priority for systems with multiple LRR or AlarmNet-i enabled Symphony's. If the system has no other external communication device, this option should be set to Stand Alone, the default priority.</p> <p>For duplicate reporting, set the priority to "Secondary" As a secondary device it reports the alarms that are sent to the primary device to the central station. If the primary device loses communication with the panel, then neither device can communicate.</p> <div style="border: 1px solid black; padding: 5px; margin-top: 10px;"> <p><b>UL</b> For UL installations, dual reporting is required (e.g. Internet with dialer backup).</p> </div> <p>Press Options tab to continue.</p>
	<p>11. Old Alarm Time sets how long an undeliverable alarm is retried for delivery to AlarmNet. If the message is not validated, it is retried until the old alarm time is reached or the message is validated. The choices available are: 10 Min., 15 Min., 30 Min., 1 Hr, 2 Hr, 4Hr, 8Hr, 12Hr, 24Hr.</p> <div style="border: 1px solid black; padding: 5px; margin-top: 10px;"> <p><b>UL</b> For UL installations, Old Alarm Time must be set to <b>10 Minutes</b>.</p> </div> <p><b>Fault Time Enter</b> in minutes 1 - 99 the time delay before AlarmNet-i notifies the control panel that there is loss of contact with the network.</p> <div style="border: 1px solid black; padding: 5px; margin-top: 10px;"> <p><b>UL</b> For UL installations, Fault Time must be set to <b>5 Minutes</b>.</p> </div> <p><b>Account Supervision</b> AlarmNet-i sends a supervision message multiple times during the supervision period. AlarmNet will transmit a communications failure alarm to the central station if the supervision message is not received within the period.</p> <p>Press <i>Reg/Test</i> tab to continue.</p> <p><b>If this is the first time AlarmNet-i has been enabled, the Symphony/Symphony-i will</b></p>



SCREEN	ACTION
	<p>reset when the <i>Reg/Test</i> tab is pressed. Allow the unit to restart and then navigate back to the screen shown below to complete AlarmNet-i registration.</p>
	<p>12. If the <b>ECP</b> and <b>IP Connection</b> status messages are green, press <b>Please Register</b> and observe the message status queue. The registration packet will be sent to AlarmNet Central and acknowledged to complete the registration process.</p>
	<p>Registration complete.</p>

### Symphony/Symphony-i Setup

Setup allows you to adjust the touch screen contrast and/or adjust the Symphony/Symphony-i speaker volume. You may also select the time interval that must pass prior to Symphony/Symphony-i going into screen saver mode (screen goes blank). Additionally, you may enter the User Setup screen, Advanced Setup screen, or Clean Screen (maintenance mode) from the "Setup" screen by pressing the corresponding button.

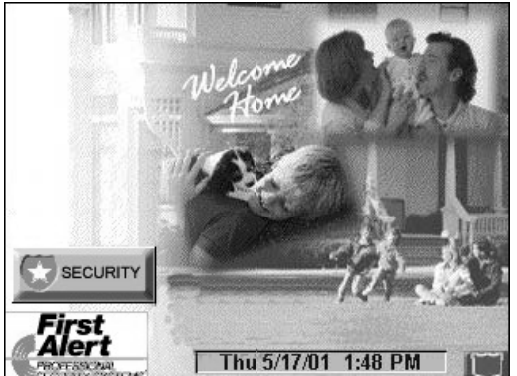
Access the "Setup" screen as follows:

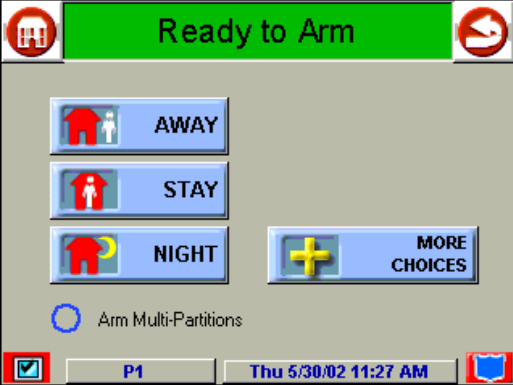
SCREEN	ACTION
	<p>1. From the "Home" screen, press the <b>SECURITY</b> button. The "Arming" screen is displayed.</p>

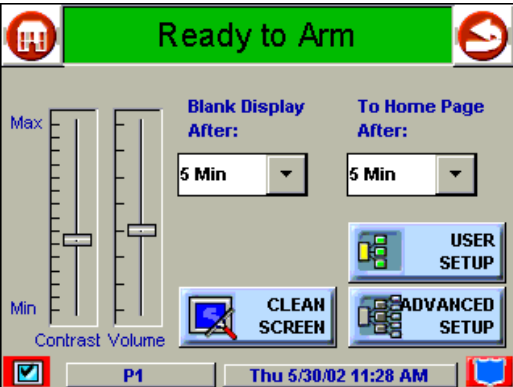
SCREEN	ACTION
	<p>2. Press the <b>MORE CHOICES</b> button. The "More Choices" screen is displayed.</p>
	<p>3. Press the <b>SETUP</b> button on the "More Choices" screen. The "Setup" screen is displayed.</p>
	<p>4. Adjust the touch screen options as described in the paragraphs that follow.</p>

**How to Adjust the Touch Screen Contrast**

You may adjust the touch screen contrast as follows:

<i><b>If...</b></i>	<i><b>Then...</b></i>
you want to increase contrast	press the slide bar above the current contrast setting.
you want to decrease contrast	press the slide bar below the current contrast setting.
another adjustment or selection is to be made	go to the corresponding paragraph in this section.
no additional adjustment or selection is to be made	press the back icon at the upper-right-hand corner of the "Setup" screen to return to the previous screen, or  press the "home" icon in the upper left-hand corner of the "Setup" screen to return to your home screen.

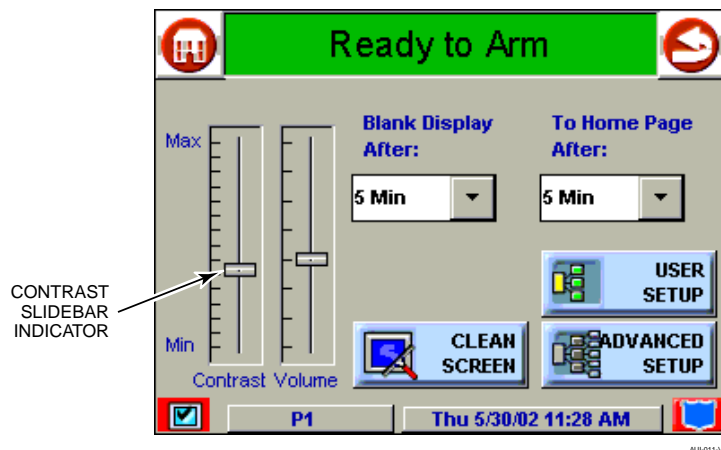

***Touch Screen Contrast Control***

**How to Adjust the Volume**

You may adjust the Symphony/Symphony-i speaker volume by pressing your finger on the touch screen slide bar associated with the "Volume" scale and doing the following:

<i><b>If...</b></i>	<i><b>Then...</b></i>
you want to increase volume	press the slide bar above the current volume setting.
you want to decrease volume	press the slide bar below the current volume setting.

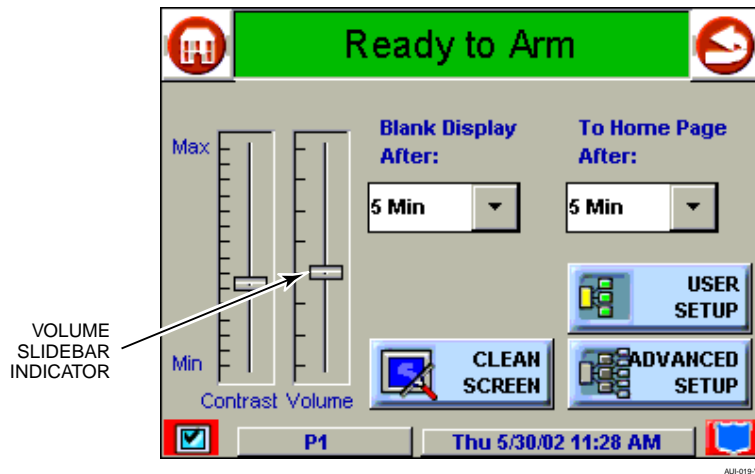

**Volume Control**

**How to Select Screen Saver Activation Time**

When Symphony/Symphony-i is not armed and not active, it will automatically go into screen saver mode (display goes blank) after the selected blank display time has expired (unless you select “never”). To select the time after which the screen will go blank, do the following:

SCREEN	ACTION
<p>The screenshot shows the 'Ready to Arm' interface. The 'Blank Display After:' dropdown menu is open, displaying a list of options: '5 Min', 'NEVER', '30 Sec', '1 Min', '2 Min', '5 Min', and '10 Min'. The '5 Min' option is highlighted in blue. The rest of the interface is identical to the previous screenshot.</p>	<p>1. Press the <b>Blank Display After:</b> "arrow" button. A pull-down menu displaying the time period options is displayed.</p>
<p>The screenshot shows the 'Ready to Arm' interface. The 'Blank Display After:' dropdown menu is open, displaying a list of options: '5 Min', 'NEVER', '30 Sec', '1 Min', '2 Min', '5 Min', and '10 Min'. The '5 Min' option is highlighted in blue. The rest of the interface is identical to the previous screenshot.</p>	<p>2. Select the time period option you want by pressing it. The pop-up window closes automatically and the selection is displayed in blue.</p> <p><b>NOTE:</b> Additional options can be viewed by using the up/down "arrows" to scroll through the time period options.</p>

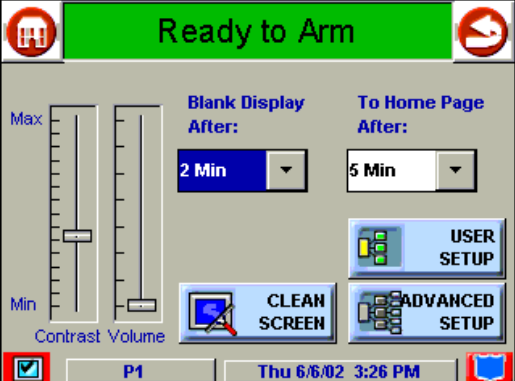
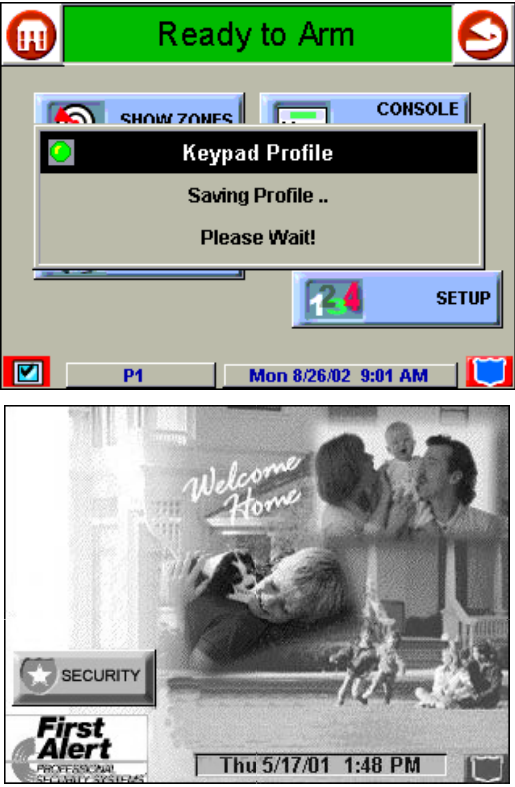
SCREEN	ACTION
	<p>3. Press either the "Home" or "Back" icon. A <b>Settings Changed!</b> pop-up window is displayed stating <b>"Keypad Profile Saving Profile – Please Wait!"</b></p>
	<p>When the Root Update is complete Symphony/Symphony-i goes to the "Home" screen or "More Choices" screen depending on whether you pressed the "Home" or "Back" icon, respectively ("Home" screen shown).</p>



## How to Set the Time and Date

You can set the time and date from the **Set Time & Date** screen. Pressing the Time and Date bar located at the bottom of each Symphony/Symphony-i screen displays the **Set Time & Date** screen.

- Since **Sync With Network Clock** is selected on the **Set Time & Date** screen, whenever Symphony/Symphony-i checks in with the server (every 15 seconds if broadband, if dial-up is selected it is whenever Symphony/Symphony-i calls in) it will get the current Greenwich Meridian Time (GMT). If the Symphony/Symphony-i time differs from GMT by 10 seconds or more, the Symphony/Symphony-i time will be reset. Additionally, Symphony/Symphony-i will send the time to the control panel every hour. This 1-hour timer starts on Symphony/Symphony-i power-up.
- If **Adjust for DST** (Daylight Savings Time) is selected, Symphony/Symphony-i will adjust for Daylight Savings time. When selected, the next time the 1-hour timer expires, the new value will be sent to the control panel.

**IMPORTANT:** This means that the Symphony/Symphony-i setting will override and overwrite the control panel time setting. That is, if the control panel is set to DST and adjusts but Symphony/Symphony-i is not, upon the 1-hour timer expiration, the control panel will be updated to the current time that is not adjusted for DST.

From the **Set Time & Date** screen, adjust either or both the time and date by pressing the increase or decrease arrow buttons as necessary until the proper month, day, year, hour, and minute are displayed.

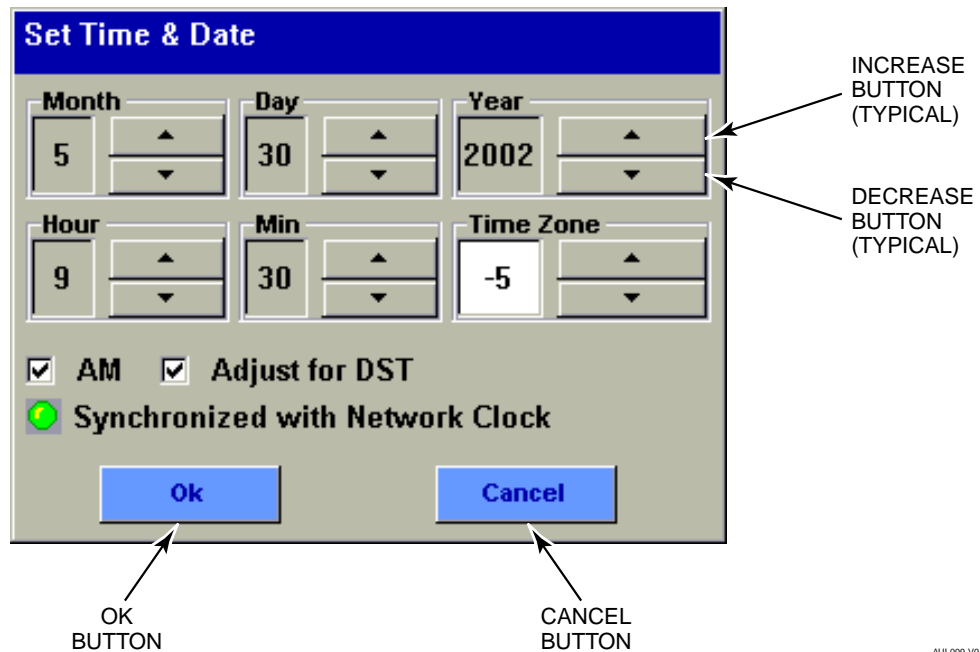

*Set Time & Date Screen*

AUI-008-V0



# AlarmNet-i Communications Setup

## In This Section

- ◆ General Information
- ◆ AlarmNet-i Menu Mode Programming

## General Information

AlarmNet-i is a fully encrypted, secure method of delivering alarm messages to a central station from a protected location, using the Internet. Connected to a control panel via ECP, an AlarmNet-i enabled Symphony/Symphony-i routes status, supervisory, and alarm messages to the AlarmNet Control Center using TCP Internet protocol and 1024-bit encryption. The AlarmNet Control then identifies, validates and forwards the message to the appropriate central station center.

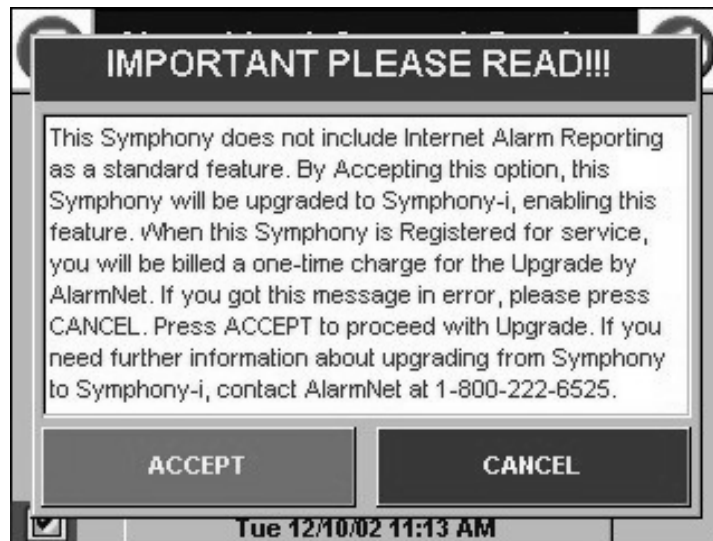

The AlarmNet-i feature is provided automatically with the purchase of a Symphony-i. If a standard Symphony was purchased, it does not come with this feature, but may be upgraded to a Symphony-i by the installer. This will incur an additional charge. To upgrade press the **AlarmNet** button on the “Central Station” screen. The following screen will appear.



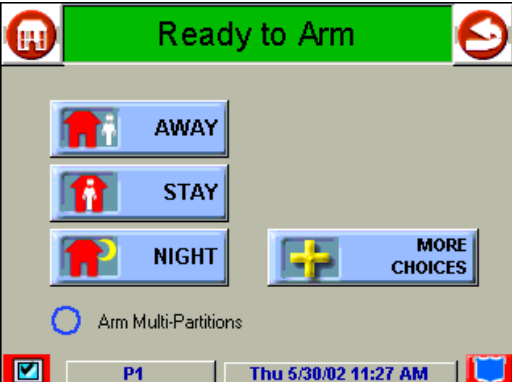
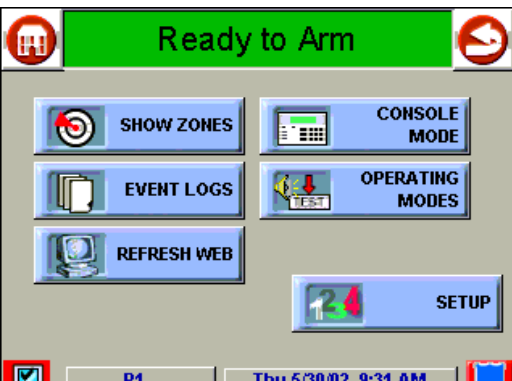
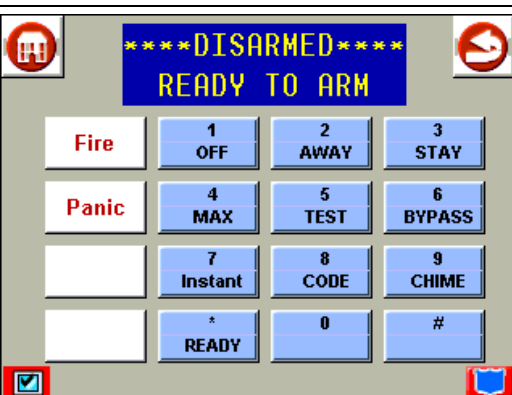

## Enabling AlarmNet-i in the Control Panel

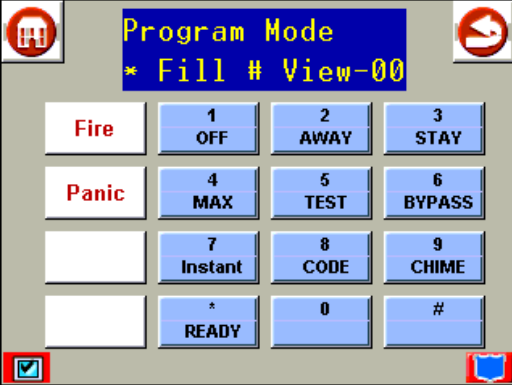
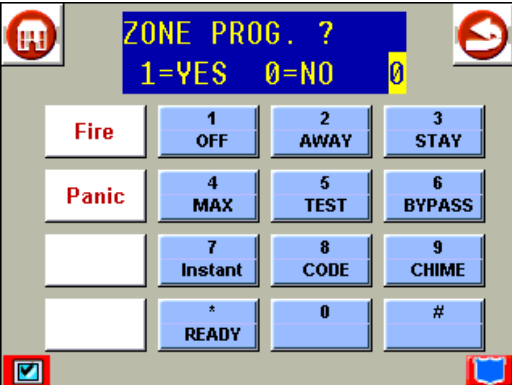
On residential control panels (e.g., FA168CPS or equivalent), you must enable LRR in the corresponding programming field (\*29). On commercial control panels (e.g., FA1660C, FA1700C or equivalent) you must enable LRR as follows:

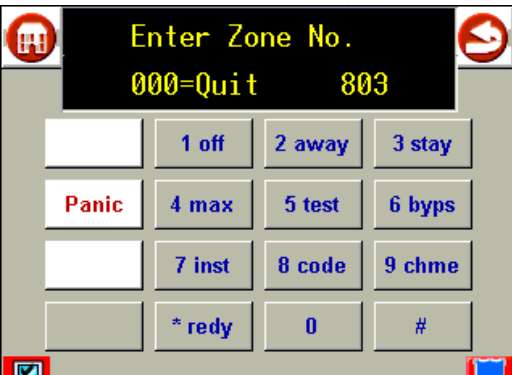
SCREEN	ACTION
	<p>1. Press the <b>SECURITY</b> button on the “Home” screen. The “Arming” screen is displayed.</p>
	<p>2. Press the <b>MORE CHOICES</b> button. The “More Choices” screen is displayed.</p>
	<p>3. Press the <b>CONSOLE MODE</b> button. The “keypad” screen appears.</p>
	<p>4. Enter the Data Field Programming Mode by entering the 4-digit <b>installer code + 8 + 000</b>. The <b>Program Mode</b> screen is displayed.</p>

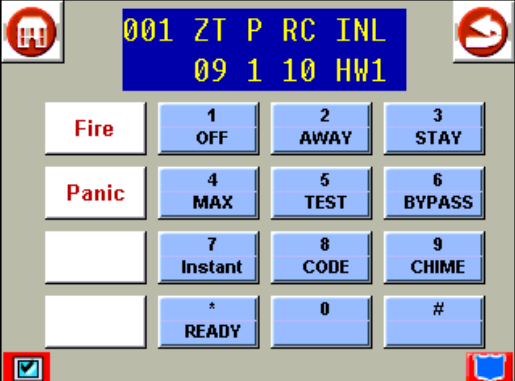
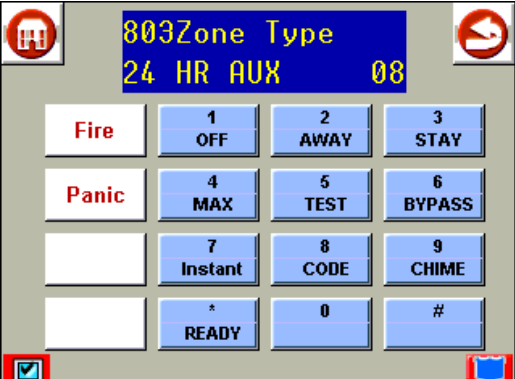
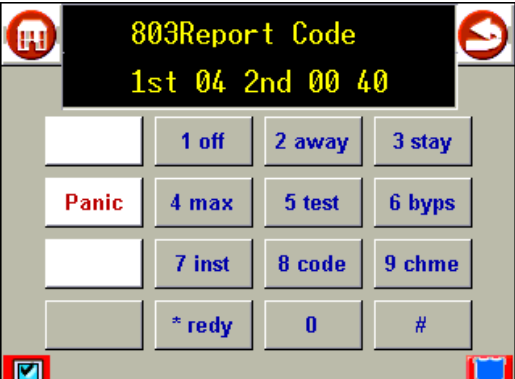
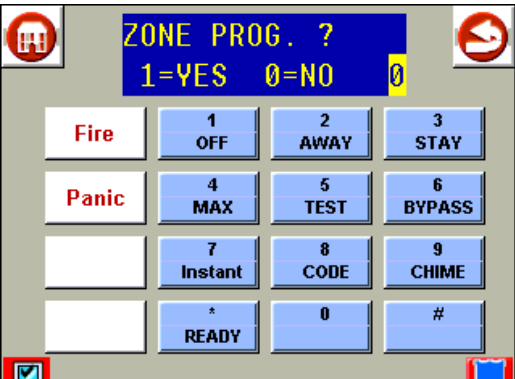
SCREEN	ACTION
	<p>5. Press <b>#93</b> to display the <b>ZONE PROG. ?</b> screen.</p>
	<p>6. Press <b>1</b> to enter Zone Programming mode (press <b>#</b> to display previous screen).</p>
	<p>7. Press <b>0</b> to skip confirmation, or press <b>1</b> to confirm a previously programmed zone.</p>
	<p>8. The AlarmNet-i supervisory zone must be within the range for ECP supervisory zones: 800 – 830; use zone <b>803[*]</b> for AlarmNet-i.</p>

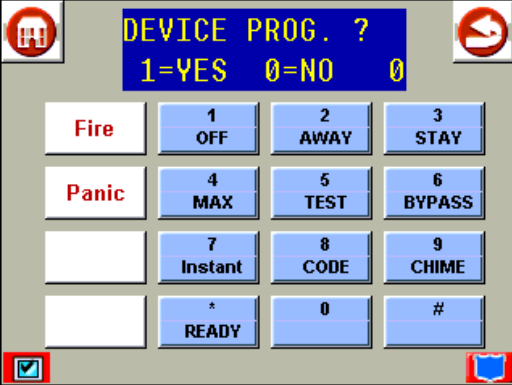
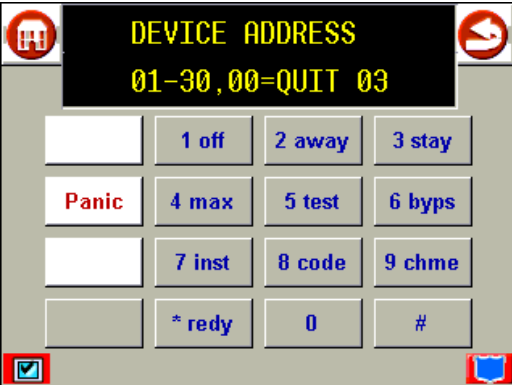
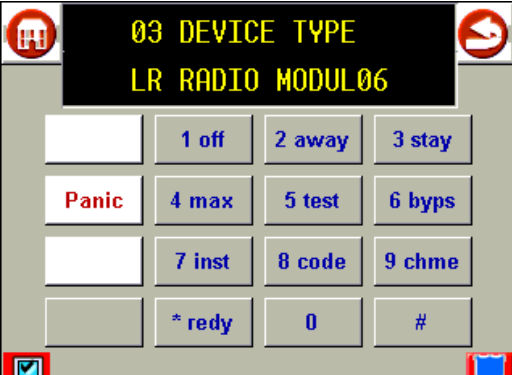
SCREEN	ACTION
	<p>9. Summary of the zone's current programming. ZT=Zone Type, P=Partition, RC=Report Code, IN=Input type and L=loop number. No entry required. Press [*] to continue.</p>
	<p>10. Enter the zone type desired for supervision of AlarmNet-i (or change it, if necessary). We recommend using Zone Type 5 (Trouble by Day/Alarm by Night) or Zone Type 19 (24-HR Trouble). Press [*] to continue.</p>
	<p>11. Enter the report code. The report code consists of 2 hexadecimal digits, each in turn consisting of 2 numerical digits. For example, for a report code of "3C," enter <b>03</b> for "3" and <b>12</b> for "C." (Refer to <i>System Communication</i> section in FA1660C II)</p> <p>Press [*] to continue.</p>
	<p>12. Scroll through the menu options by repeatedly pressing 0 until <b>DEVICE PROG?</b> appears.</p>

SCREEN	ACTION
	<p>13. Press 1 to enter <b>DEVICE PROGRAMMING</b>.</p>
	<p>14. Enter LRR ECP address <b>03[*]</b>.</p>
	<p>15. Select Long Range Radio DEVICE TYPE 6 by entering <b>06[*]</b>.</p>
	<p>16. Press 0[*] to advance to the next screen.  <b>NOTE:</b> The radio programming feature is not available with AlarmNet-i.</p>

SCREEN	ACTION
	<p>17. Press <b>00[*]</b> to quit device programming.</p>
	<p>18. Press <b>1</b> to quit menu mode.</p>
	<p>19. Press <b>#99</b> to exit programming mode.</p>
	<p>Panel programming complete. The Symphony/Symphony-i screen will briefly display a reset message from the panel. Proceed to Symphony/Symphony-i programming section.</p>



# User Codes

**In This Section**

- ◆ Introduction to User Code Setup
- ◆ How to Access User Setup
- ◆ How to Add a User

**Introduction to User Code Setup**

Each user must be assigned a name with a corresponding 4-digit user code in order to gain access to various features and functions. Through Symphony/Symphony-i, you may program users to access any and all of the following systems:





- Fire/Burglary
- Internet

Users for the systems are programmed in a central user setup location that provides the specific questions for the user pertaining to each system. You may want these users to be the same, but there are situations in which you may want a user to have access to one system (e.g., Internet) without having access to another (e.g., the Fire/Burglary system).

**How to Access User Setup**

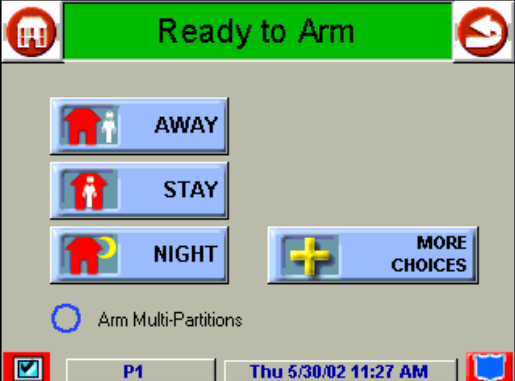

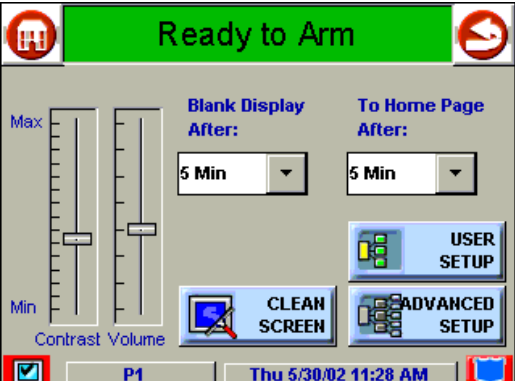

Access User Setup as follows:



SCREEN	ACTION
	<p>1. From the "Home" screen, press the <b>SECURITY</b> button. The "Arming" screen is displayed.</p>

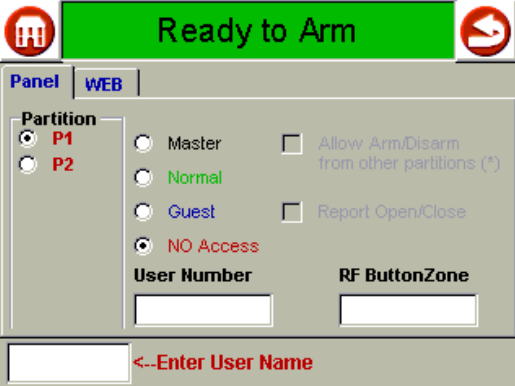

SCREEN	ACTION
	<p>2. Press the <b>MORE CHOICES</b> button. The "More Choices" screen is displayed.</p>
	<p>3. Press the <b>SETUP</b> button on the "More Choices" screen. The "Setup" screen is displayed.</p>
	<p>4. Press the <b>USER SETUP</b> button on the "Setup" screen. The User Setup screen is displayed.</p>
	

## How to Add a User

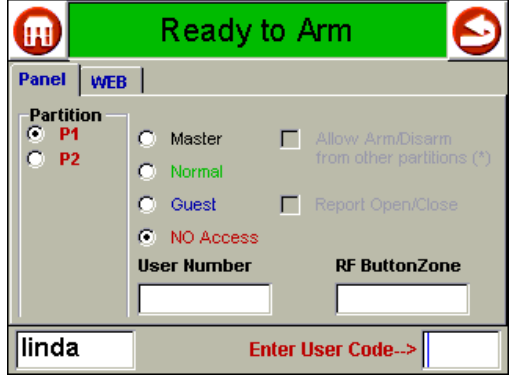
Add a user as follows:

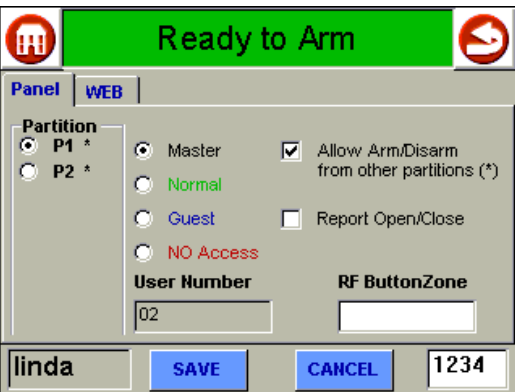

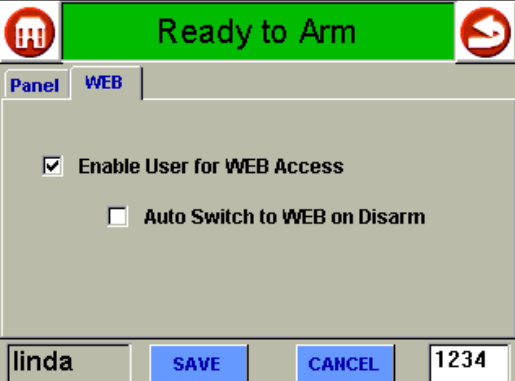
SCREEN	ACTION
	<p>1. To add a user, press the <b>ADD USER</b> button. The "User Authorization" screen is displayed with the instructions "<b>Enter Authorized Code</b>".</p>
	<p>2. Enter your "Installer" code. The "User Options" screen is displayed.</p>
	<p>3. Press the box next to <b>Enter User Name</b>. The <b>Enter Data</b> keyboard screen is displayed.</p>
	<p>4. Type in the user name and press the <b>OK</b> button. The "User Options" screen is displayed with <b>Enter User Code...</b> displayed.</p>

SCREEN	ACTION
	<p>5. Touch the box next to <b>Enter User Code...</b> The "User Authorization" screen is displayed with the instructions "<b>Enter 4 Digits</b>".</p>
	<p>6. Enter the 4-digit code for this user. The "User Options" screen is displayed with the user's name and code displayed.</p>
	<p>7. Select the partitions and access level for this user.</p> <p>If you are sending opening/closing reports for this user, enter the 3-digit User Number to identify the user.</p> <p>If assigning this user to wireless key, enter one of the zone numbers of the keyfob (the wireless key must be programmed first before it can be assigned to a user).</p> <p><b>NOTE:</b> The User Number and RF button zone fields will only be displayed when the Installer Code is used to program the user.</p> <p><b>NOTE:</b> If this user is to have Internet access, continue to step 7. If this user is to have security access only, press the <b>SAVE</b> button at this time. Press the <b>WEB</b> tab on the "User Options" screen. The "WEB access" screen is displayed.</p>

SCREEN	ACTION
 <p>The screenshot shows a 'Ready to Arm' screen with a green header. Below the header, there is a 'Panel' tab set to 'WEB'. Two checkboxes are visible: 'Enable User for WEB Access' (checked) and 'Auto Switch to WEB on Disarm' (unchecked). At the bottom, there is a text field containing 'linda', a 'SAVE' button, a 'CANCEL' button, and a numeric field containing '1234'.</p>	<p>8. To provide this user with Internet access press the box next to <b>Enable User for Web Access</b> until a check appears. You may also select the <b>Auto Switch to WEB on Disarm</b> option at this time. Press the <b>Save</b> button. The system will save the configuration. When the save is complete, the <b>User Setup</b> screen is displayed with the new user's name shown.</p>
 <p>The screenshot shows a 'Ready to Arm' screen with a green header. Below the header, the title 'User Setup' is displayed. A list of users shows 'linda' selected with a radio button. To the right of the list are three buttons: 'ADD USER' (with a plus icon), 'EDIT USER' (with a pencil icon), and 'DELETE USER' (with a minus icon).</p>	

## How to Delete a User

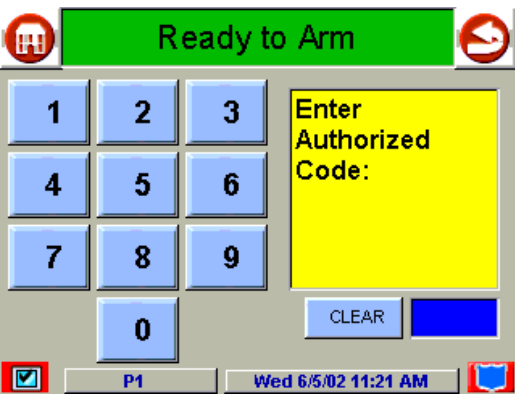
Delete a User as follows:

ACTION	SCREEN
	<p>Three selections are available: add a user, edit a user, or delete a user.</p> <p>1. To delete a user, touch the circle next to the user to be deleted and press the <b>DELETE USER</b> button. The "User Authorization" screen is displayed with the instructions "<b>Enter Authorized Code</b>".</p>
	<p>2. Enter your "Installer" code. The <b>Confirm Delete</b> screen is displayed.</p>
	<p>3. Press the appropriate button. The <b>User Setup</b> screen is displayed.</p>
	

## How to Edit a User

Edit a user as follows:

SCREEN	ACTION
	<p>Three selections are available: add a user, edit a user, or delete a user.</p> <p>1. To edit a user, touch the circle next to the user to be edited and press the <b>EDIT USER</b> button. The "User Authorization" screen is displayed with the instructions "<b>Enter Authorized Code</b>".</p>
	<p>2. Enter your "Installer" code. The "User Options" screen is displayed.</p>
	<p>3. Select whatever options you wish to select for this user and press the <b>Save</b> button. The configuration changes are saved and you are returned to the <b>User Setup</b> screen.</p>





# Maintenance

**In This Section**

- ◆ *About Symphony/Symphony-i Maintenance*
- ◆ *How to Clean Symphony/Symphony-i*

**About Symphony/Symphony-i Maintenance**

With the exception of normal cleaning, Symphony/Symphony-i is maintenance free.

**How to Clean Symphony/Symphony-i**

**IMPORTANT:** Do not use an abrasive cleaning agent or abrasive cloth when cleaning Symphony/Symphony-i or damage to the touch screen may occur.

Clean Symphony/Symphony-i as follows:

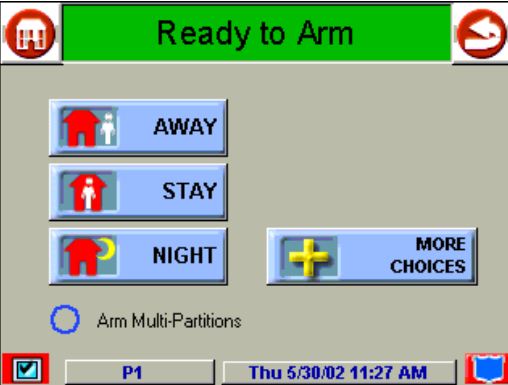
SCREEN	ACTION
	<p>1. From the "Home" screen, press the <b>SECURITY</b> button. The "Arming" screen is displayed.</p>
	<p>2. Press the <b>MORE CHOICES</b> button. The "More Choices" screen is displayed.</p>

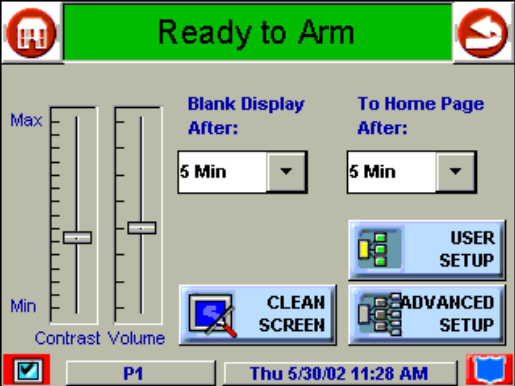
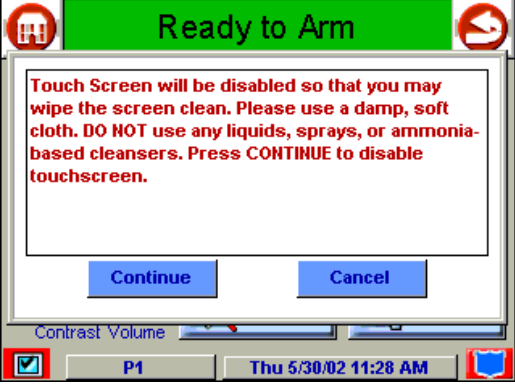
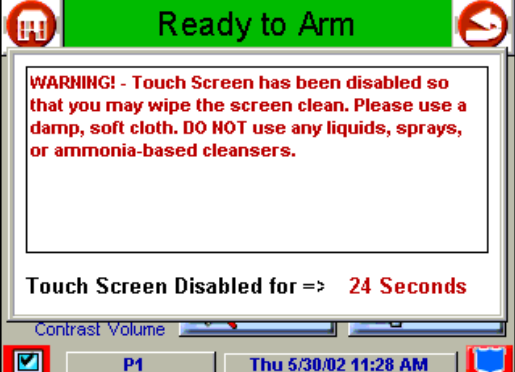
SCREEN	ACTION
	<p>3. Press the <b>SETUP</b> button on the "More Choices" screen. The "Setup" screen is displayed.</p>
	<p>4. Press the <b>CLEAN SCREEN</b> button. A pop-up window displaying "Touch Screen will be disabled so that you may wipe the screen clean. Please use a damp, soft cloth. DO NOT use any liquids, sprays, or ammonia-based cleansers. Press CONTINUE to disable touchscreen."</p> <p>When the <b>Continue</b> button is pressed the "Touch Screen Disabled for → 30 Seconds". During these 30 seconds the touch screen should be wiped clean of fingerprints using a mild soap solution and a soft cloth. When the counter reaches zero, the window automatically closes and the touch screen is active.</p>
	<p>NOTE: Do not spray cleaning agent directly on the screen, spray it on cloth then wipe surface area.</p>
	

## Routine Care

- Treat the components of the security system as you would any other electrical equipment. Do not slam sensor-protected doors or windows.
- Keep dust from accumulating on the keypad and all protective sensors, particularly on motion sensors and smoke detectors.
- The keypad and sensors should be cleaned carefully with a dry soft cloth. ***Do not spray water or any other fluid on the units.***



# Troubleshooting

## In This Section

- ◆ *Troubleshooting* ◆ *Symphony/Symphony-i LED Operation*
- ◆ *Diagnostics*

## Troubleshooting

For troubleshooting procedures, refer to the Control Panel Installation Guide.

## Diagnostics



### About Diagnostics

A series of diagnostic and calibration tests is provided that allows verification of correct operation of Symphony/Symphony-i and its connections to the security system and the Internet. There are a total of six diagnostic tests and one calibration procedure.

### How to Access the Diagnostics

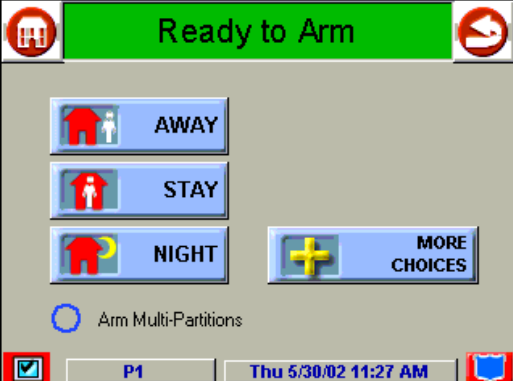
To access diagnostics, do the following:

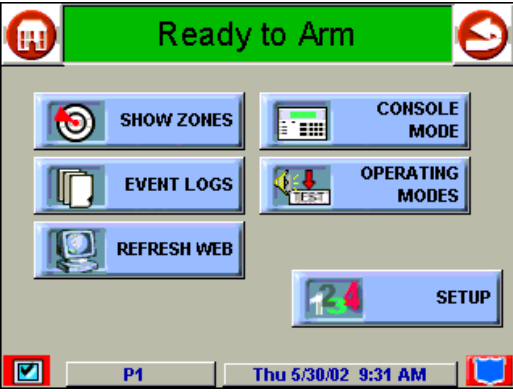
SCREEN	ACTION
	<p>1. From the "Home" screen, press the SECURITY button. The "Arming" screen is displayed.</p>
	<p>2. From the " Arming" screen press the <b>MORE CHOICES</b> button. The "More Choices" screen is displayed.</p>

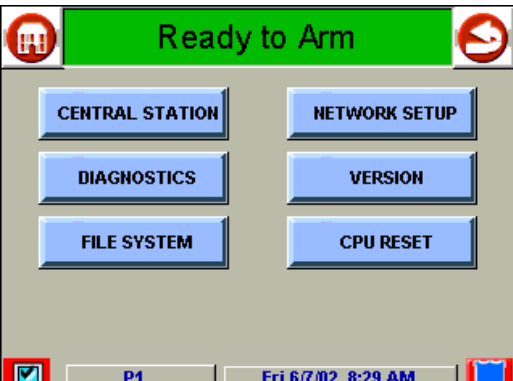
SCREEN	ACTION
	<p>3. Press the <b>SETUP</b> button on the "More Choices" screen. The "Setup" screen is displayed.</p>
	<p>4. Press the <b>Advanced Setup</b> button on the "Setup" screen. The <b>Enter Authorized Code:</b> authorization screen is displayed.</p>
	<p>5. Enter your 4-digit Installer code. The "Advanced Setup" menu screen is displayed.</p>
	<p>6. Press the <b>Diagnostics</b> button on the "Advanced Setup" menu screen. The "Diagnostics" screen is displayed.</p>

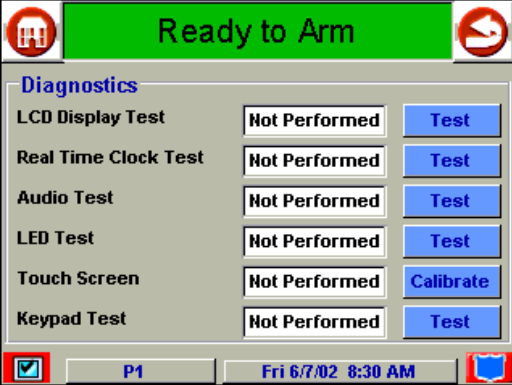
SCREEN	ACTION
	

### Performing Diagnostics

Select any diagnostic test or calibration procedure from the Diagnostics screen by pressing its associated **Test** or **Calibrate** button. All or any individual test may be run when you access the Diagnostics screen; however, each test must be performed one at a time.

At any time when a test is not being performed, you can press:

- the back button icon at the upper-right corner of the Diagnostics screen to return to the previous screen, or
- the home button icon in the upper left-hand corner of the Diagnostics screen to return to your home page.





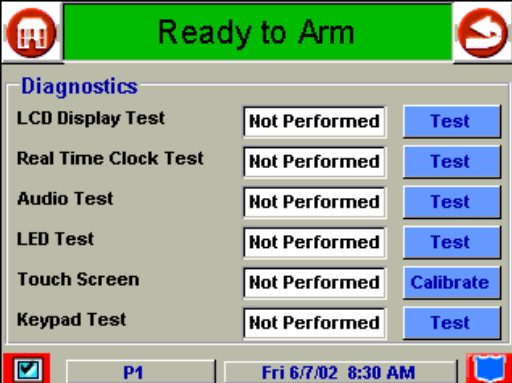

Once the Diagnostics screen is exited, subsequent entry to this screen displays all test options as "Not Performed."

### LCD Display Test

Perform the LCD Display Test as follows:

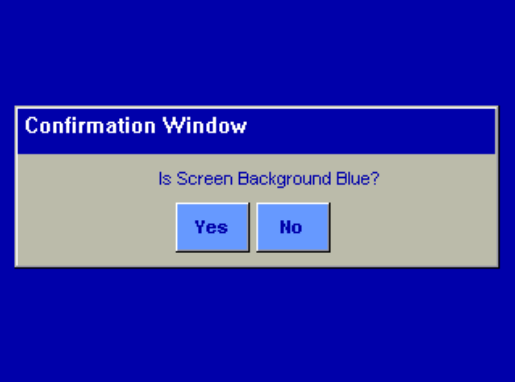
SCREEN	ACTION
	<p>1. When you press the Test button associated with the LCD Display Test, a pop-up "Confirmation Window" is displayed in the center of the screen with an all green background. Within the Confirmation Window the question "Is Screen Background Green?" is displayed.</p>

SCREEN	ACTION
	<p>2. When you press the <b>Yes</b> or <b>No</b> button accordingly, the Red Background Pop-Up Confirmation Window is displayed in the center of the screen with an all red background. Within the Confirmation Window the question "Is Screen Background Red?" is displayed.</p>
	<p>3. When you press the <b>Yes</b> or <b>No</b> button accordingly, the Blue Background Pop-Up Confirmation Window is displayed in the center of a blank screen with an all blue background as shown below. Within the Confirmation Window the question "Is Screen Background Blue?" is displayed.</p>
	<p>4. When you press the <b>Yes</b> or <b>No</b> button accordingly, the Color Bar Pop-Up Confirmation Window is displayed in the center of the screen as shown below. Within the Confirmation Window the question "Do you see Color Bars (Blk, R, G, LGr, B, M Y, W)?" is displayed.</p>
	<p>5. When you press the <b>Yes</b> or <b>No</b> button accordingly, automatically the contrast test begins from low to high. "Changing Contrast.." is displayed in the center of the screen during this time.</p> <p>At the conclusion of the contrast test a Pop-Up Confirmation Window is displayed in the center of the screen. Within the Confirmation Window the question "Contrast Changed (Low to High)?" is displayed.</p>

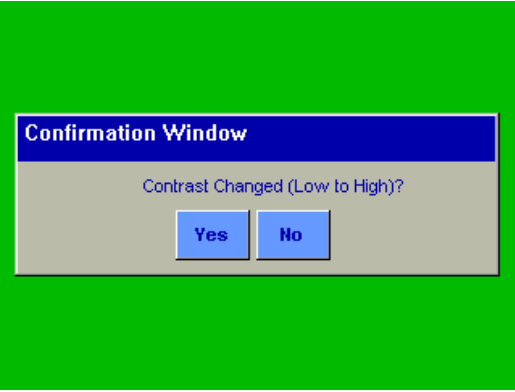
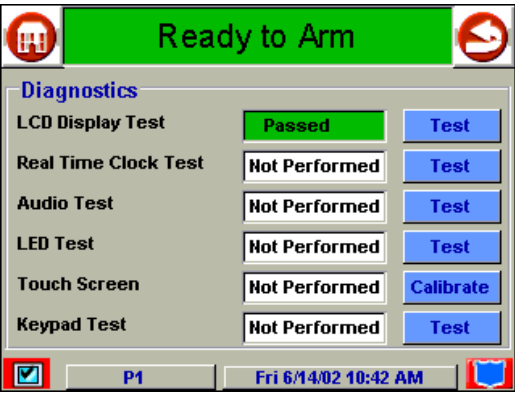

SCREEN	ACTION
  	<p>6. When you press the <b>Yes</b> or <b>No</b> button accordingly, the "Diagnostics" screen is displayed with the LCD Display Test results ("Passed" or "Failed") shown in the test status column.</p> <p><b>NOTE:</b> If the response was no (the <b>No</b> button is pressed) to any question of this test, when the system is returned to the Diagnostics screen, "Failed" is displayed in test status column.</p>

### Real Time Clock Test

Perform the Real Time Clock Test as follows:

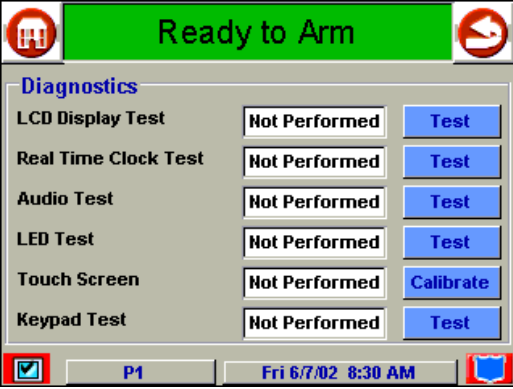
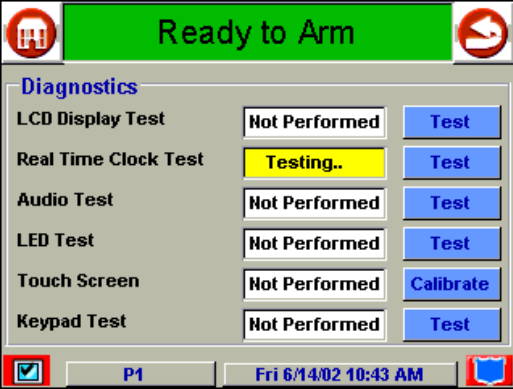
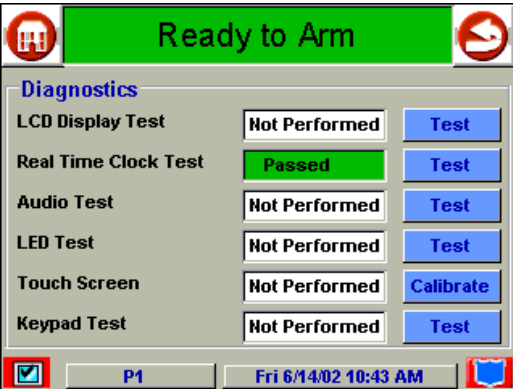
SCREEN	ACTION
 <p>The screenshot shows a green header 'Ready to Arm' with a red alarm icon on the left and a red arrow icon on the right. Below the header is a 'Diagnostics' section with a list of tests: LCD Display Test, Real Time Clock Test, Audio Test, LED Test, Touch Screen, and Keypad Test. Each test has a status box and a button. The Real Time Clock Test status is 'Not Performed' and the button is 'Test'. The bottom of the screen shows a status bar with a checkmark icon, 'P1', and the date/time 'Fri 6/7/02 8:30 AM'.</p>	<p>When you press the <b>Test</b> button associated with the Real Time Clock Test, "Testing.." is displayed in the test status column on the "Diagnostics" screen.</p>
 <p>The screenshot is identical to the previous one, but the Real Time Clock Test status box now contains 'Testing..' in yellow text. The 'Test' button remains blue.</p>	<p>At the conclusion of the test, either a green "Passed." or a red "Failed." is displayed in the test status column on the "Diagnostics" screen.</p>
 <p>The screenshot is identical to the previous ones, but the Real Time Clock Test status box now contains 'Passed' in green text. The 'Test' button remains blue.</p>	

Audio Test

Perform the Audio Test as follows:

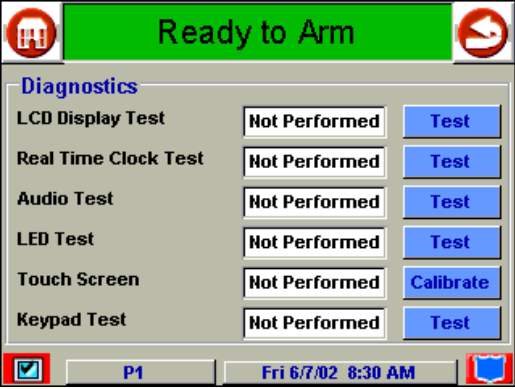
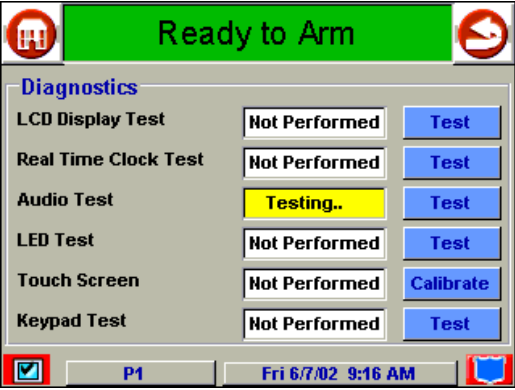
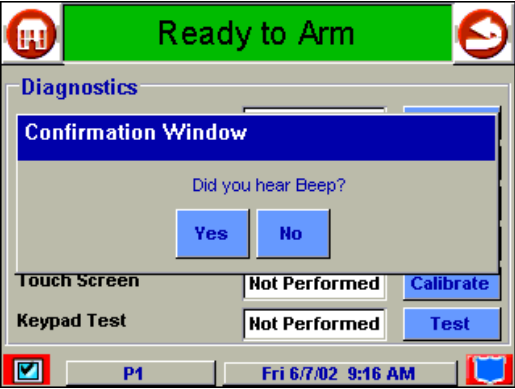
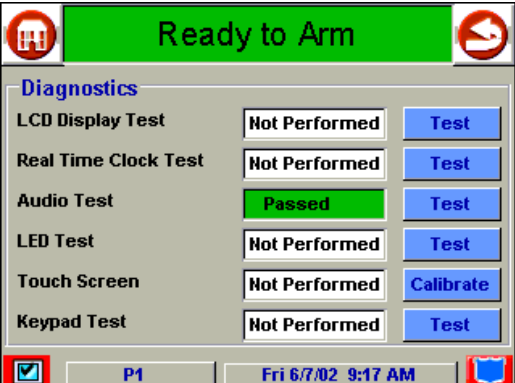
SCREEN	ACTION
	<p>When you press the <b>Test</b> button associated with the Audio Test "Testing.." is displayed (yellow) in the test status column on the "Diagnostics" screen while beeps sound from the speaker. At the conclusion of the test, a pop-up "Confirmation Window" is displayed in the center of the "Diagnostics" screen.</p> <p>Within the Confirmation Window the question "Did you hear Beep?" is displayed.</p>
	<p>When you press the <b>Yes</b> button, a green "Passed." indication is displayed in the test status column on the "Diagnostics" screen.</p>
	<p>When you press the <b>No</b> button, a red "Failed." indication is displayed in the test status column on the "Diagnostics" screen.</p>
	

LED Test

Perform the LED Test as follows:

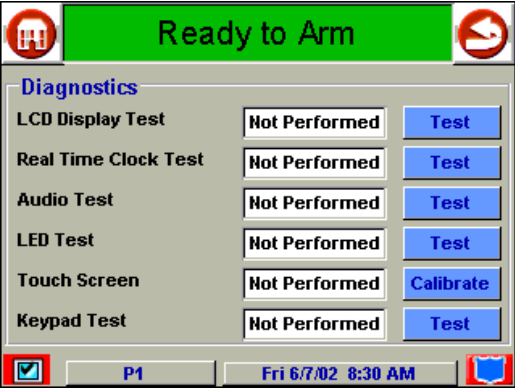
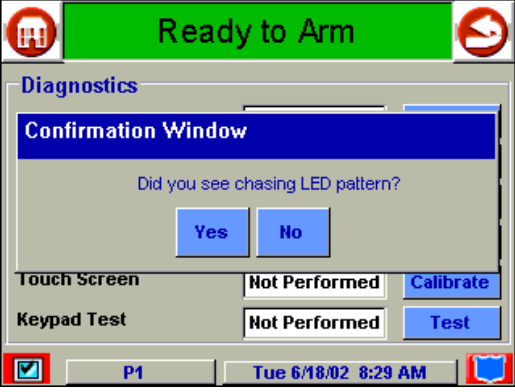
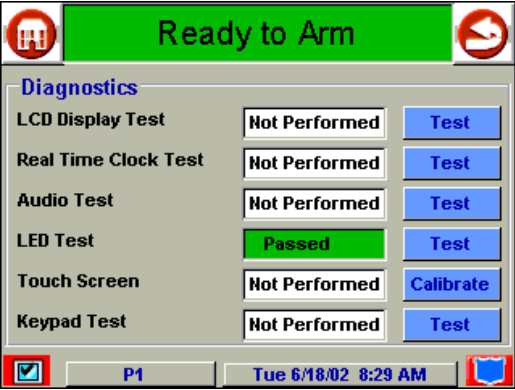
SCREEN	ACTION
 <p>The screenshot shows the 'Ready to Arm' screen with a green header. Below the header is a 'Diagnostics' section with a table of tests. The 'LED Test' row shows 'Not Performed' in a white box and a blue 'Test' button. Other tests include LCD Display Test, Real Time Clock Test, Audio Test, Touch Screen (Calibrate), and Keypad Test. The status bar at the bottom shows 'P1' and 'Fri 6/7/02 8:30 AM'.</p>	<p>1. When you press the <b>Test</b> button associated with the LED Test, "Testing.." is displayed (yellow) in the test status column on the "Diagnostics" screen while the 4 LEDs light sequentially, left to right (amber, red, green, green), 5 times. At the conclusion of the test, a pop-up "Confirmation Window" is displayed in the center of the "Diagnostics" screen.</p>
 <p>The screenshot shows the 'Ready to Arm' screen with a green header. A 'Confirmation Window' pop-up is centered over the 'Diagnostics' section. The pop-up has a blue header and asks 'Did you see chasing LED pattern?' with 'Yes' and 'No' buttons. Below the pop-up, the 'LED Test' status is now 'Testing..' in a yellow box. The status bar at the bottom shows 'P1' and 'Tue 6/18/02 8:29 AM'.</p>	<p>2. Within the Confirmation Window the question "Did you see chasing LED pattern?" is displayed.</p> <p>If you press the <b>Yes</b> button, a green "Passed." indication is displayed in the test status column on the "Diagnostics" screen.</p> <p>If you press the <b>No</b> button, a red "Failed." indication is displayed in the test status column on the "Diagnostics" screen.</p>
 <p>The screenshot shows the 'Ready to Arm' screen with a green header. The 'LED Test' status is now 'Passed' in a green box. The status bar at the bottom shows 'P1' and 'Tue 6/18/02 8:29 AM'.</p>	

### Keypad Test

Perform the Keypad Test as follows:

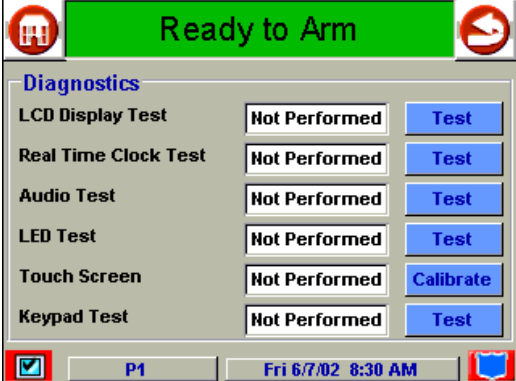
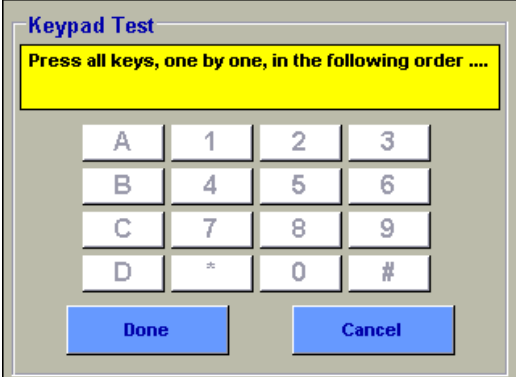
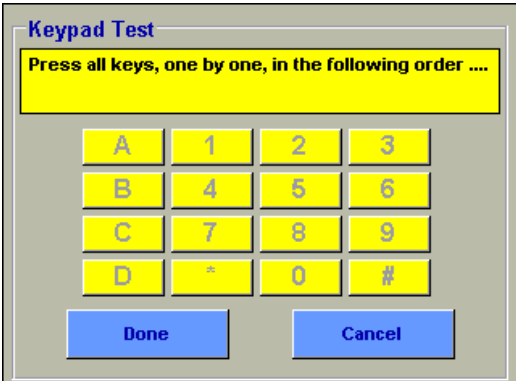

NOTE: The Keypad Test is only used on the 8142.

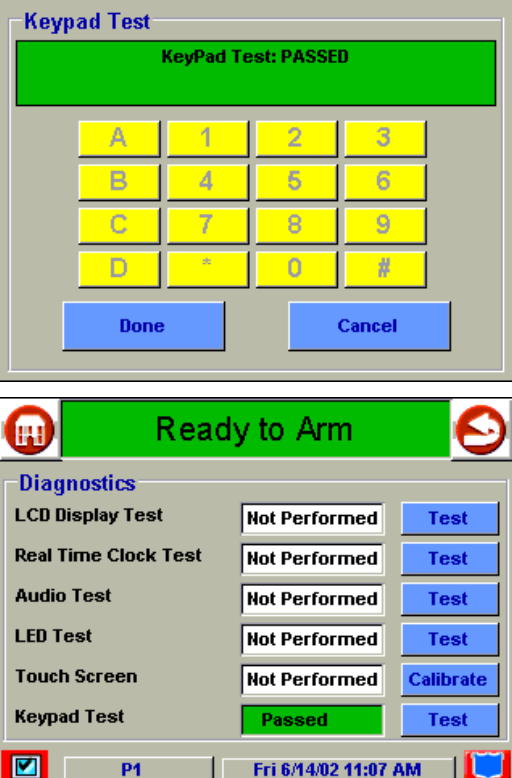

SCREEN	ACTION
	<p>1. When you press the <b>Test</b> button associated with the LED Test, a <b>Keypad Test</b> screen is displayed as shown. Within this screen you are asked to <b>Press all keys, one by one, in the following order...</b></p>
	<p>2. On the Keypad (not the touch screen) press A, 1, 2, 3, B, 4, 5, 6, C, 7, 8, 9, D, *, 0, #, then press the <b>Done</b> button on the <b>Keypad Test</b> screen. As each key is pressed the background for the corresponding graphically displayed key changes to yellow.</p> <p><b>NOTE:</b> Pressing the <b>Cancel</b> button at any time (even if several keys have been pressed) returns the system to the "Diagnostics" screen.</p>
	



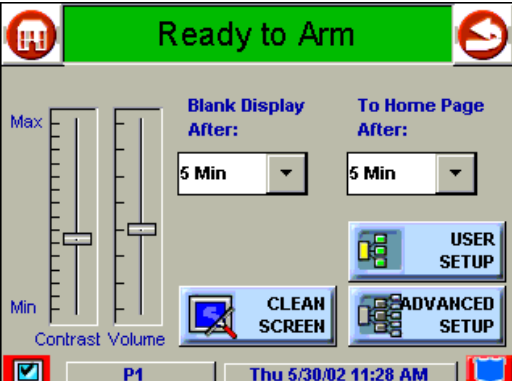

SCREEN	ACTION
	<p>If the Keypad is functioning correctly and the keys were pressed in the order above, a green <b>PASSED</b> message is displayed in the center of the <b>Keypad Test</b> screen. The system then automatically returns to the "Diagnostics" screen.</p> <p>If the keypad is not functioning correctly or the keys were pressed out of order, a red <b>FAILED</b> message is displayed in the center of the <b>Keypad Test</b> screen. The system then automatically returned to the "Diagnostics" screen.</p>

### Touch Screen Calibration

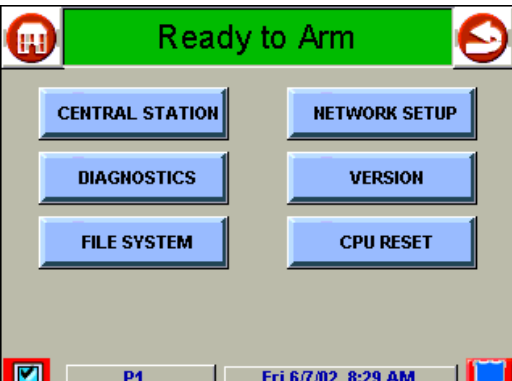

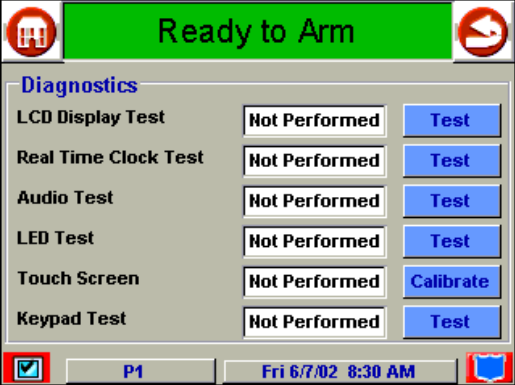
Calibrate the touch screen as follows:

ACTION	SCREEN
	<p>1. From the "Home" screen, press the SECURITY button. The "Arming" screen is displayed.</p>
	<p>2. From the "Arming" screen press the <b>MORE CHOICES</b> button. The "More Choices" screen is displayed.</p>

ACTION	SCREEN
	<p>3. Press the <b>SETUP</b> button on the "More Choices" screen. The "Setup" screen is displayed.</p>
	<p>4. Press the <b>Advanced Setup</b> button on the "Setup" screen. The <b>Enter Authorized Code:</b> authorization screen is displayed.</p>
	<p>5. Enter your 4-digit installer code. The "Advanced Setup" menu screen is displayed.</p>
	<p>6. Press the <b>Diagnostics</b> button on the "Advanced Setup" menu screen. The "Diagnostics" screen is displayed.</p>

ACTION	SCREEN
	<p>7. Begin the Touch Screen calibration from the "Diagnostics" screen by pressing the <b>Calibrate</b> button. When the <b>Calibrate</b> button is pressed, the <b>Touch Screen Calibration</b> screen is displayed.</p>
	<p>8. Within the <b>Touch Screen Calibration</b> screen you are asked to <b>Touch the center of the square displayed in the corner</b>. Press the center of the square.</p>
	<p>9. When this square is touched the <b>Touch Screen Calibration</b> screen displays <b>Next Point.. Touch the center of the square</b>. Press the center of the square. <b>The Touch Screen Calibration</b> screen displays <b>Verifying Calibration.. Touch the center of the square</b>.</p>
	<p><b>NOTE:</b> If no touch is made within 5 seconds, <b>No Touch Detected.. Try Again.</b> is displayed in the center of the <b>Touch Screen Calibration</b> screen.</p>

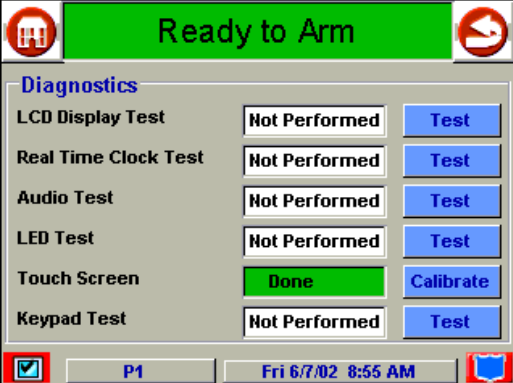

ACTION	SCREEN
<p style="text-align: center;"><b>Touch Screen Calibration</b></p> <p style="text-align: center;">Verifying Calibration .. Touch the center of the square</p> <div style="text-align: center; margin: 20px 0;">  </div> <p style="text-align: center;"><b>Touch Screen Calibration</b></p> <p style="text-align: center;">CALIBRATION SUCCESSFUL.</p> 	<p>9. Press the center of the square. If touch screen calibration was successful, <b>CALIBRATION SUCCESSFUL</b> is displayed momentarily. You are then returned automatically to the "Diagnostics" screen.</p> <p>If touch screen calibration was not successful, <b>Calibration Unsuccessful</b> is displayed momentarily. You are then returned automatically to the first <b>Touch Screen Calibration</b> screen.</p> <p>NOTE: You will progress through the <b>Touch Screen Calibration</b> screens regardless of where you touch. To successfully calibrate the touch screen you must press the center of the box on each screen.</p>
<div style="text-align: center; margin: 20px 0;">  </div> <p style="text-align: center;"><b>Touch Screen Calibration</b></p> <p style="text-align: center;">No Touch Detected.. Try Again.</p>	<p><b>NOTE:</b> If no touch is made within 5 seconds, <b>No Touch Detected.. Try Again.</b> is displayed in the center of the <b>Touch Screen Calibration</b> screen.</p>

## **Symphony/Symphony-i LED Operation**

Your Symphony/Symphony-i has four LEDs that are labeled: WEB (yellow), ARMED (red), READY (green), and MESSAGE (yellow). The status of each of these LEDs indicates specific operational states. These states are:

- Normal (idle)
- Software download
- Software download - Failure Modes

Each LED can have four different status indications: ON, OFF, FAST BLINK, and SLOW BLINK. All LEDs do not use all of the above states. Details are provided below.

### **LEDs During Normal (Idle) State**

<b>LED</b>	<b>DESCRIPTION</b>
WEB	ON – Connected to Internet. OFF – Not connected. FAST BLINK – Either sending or receiving data. SLOW BLINK – Connecting to server (BB) or dialing to RAS server (DU).
ARMED	ON – Security system is armed. OFF – Security system is not armed.
READY	ON – Security system is disarmed and ready to arm. OFF – Security system is disarmed but not ready. Faults/troubles present.

**LEDs During Software Downloading**

LED	DESCRIPTION
WEB	ON – Obtained IP address (via either DHCP client or static IP assignment) (BB) or established link to RAS server (DU). SLOW BLINK – Connecting to server (BB) or dialing (DU).
ARMED	ON – Connected to server. FAST BLINK – Could not connect to server (no route or authentication failure). SLOW BLINK – Connecting to server.
READY	ON – Successfully downloaded configuration data. FAST BLINK – Could not download configuration data or if with ARMED FAST BLINK then it connected to server but failed authentication.
MESSAGE	ON – Erasing application code. SLOW BLINK – Downloading application code. VERY SLOW BLINK – Verifying CRC after successful code download.

**LED Operation When Software Download Fails**

There are the following sequences providing the extra failure information:

1. CRC failure 1 (calculated CRC does not match CRC provided with binary)
  - WEB, ARMED, READY and MESSAGE – all FAST BLINK for 3 seconds, following
  - WEB, ARMED, READY and MESSAGE ON for 3 seconds and following
  - WEB, ARMED, READY and MESSAGE FAST BLINK for 3 seconds.
2. CRC failure 2 (calculated network CRC does not match CRC provided with binary)
  - WEB, ARMED, READY and MESSAGE – all FAST BLINK for 3 seconds, following
  - WEB, ARMED, READY and MESSAGE SLOW BLINK for 3 seconds and following
  - WEB, ARMED, READY and MESSAGE FAST BLINK for 3 seconds.



# Specifications

## Specifications

### FA800KP/FA800KP-i

<b>MECHANICAL</b>	
Dimensions:	
Width:	7 ¾ inches
Height:	8 ¼ inches
Depth:	1 ¼ inches
<b>ELECTRICAL</b>	
Operating Voltage:	
Current Drain:	
Standby - LCD off, Sound off	150mA
Active - LCD on, Sound off	350mA
Alarm - LCD off, Sound on	200mA maximum
Alarm - LCD on, Sound on	400mA maximum

### FA850KP/FA850KP-i

<b>MECHANICAL</b>	
Dimensions:	
Width:	8 inches
Height:	5 ¾ inches
Depth:	1 ½ inches
<b>ELECTRICAL</b>	
Operating Voltage:	
Current Drain:	
Standby - LCD off, Sound off	150mA
Active - LCD on, Sound off	350mA
Alarm - LCD off, Sound on	200mA maximum
Alarm - LCD on, Sound on	400mA maximum



# Glossary



## Glossary

**DHCP (Dynamic Host Configuration Protocol).** Provides a mechanism for allocating IP addresses dynamically so that addresses can be reused when hosts no longer need them.

**DNS (Domain Name System).** A distributed hierarchical naming system used to resolve domain names (e.g., www.yahoo.com) into numerical IP addresses (e.g., 204.17.25.1).

**DSL - Digital Subscriber Line**

**Gateway IP Address -** A gateway (sometimes called a router) is a computer and/or software used to connect two or more networks (including incompatible networks) and translates information from one network to the other. The Gateway IP address is the IP address for the gateway.

**IP - Internet Protocol**

**IP Address -** A unique number consisting of 4 parts separated by periods, sometimes called a "dotted quad.," for example: 204.17.29.11, assigned to every computer/workstation connected to the Internet. IP numbers can be "static" (assigned and unchanging) or "dynamic," assigned via DHCP at each and every startup.

**ISP - Internet Service Provider**

**LAN - Local Area Network**

**MAC Address -**The hardware address of a device connected to a network.

**NAT - Network Address Translation**

**PPP - Point-to-Point Protocol**

**PPPoE - Point-to-Point Protocol over Ethernet**

**RCPP - Remote Control Proxy Protocol**

**Subnet Mask -** A Subnet is a portion of a network that shares a network address with other portions of the network, and is distinguished by a subnet number. The Subnet Mask is a 32-bit address mask used in IP to indicate the bits of an IP address that are being used for the subnet address.

**TCP/IP - Transmission Control Protocol / Internet Protocol (packet-based protocol)**

**UDP - User Datagram Protocol**

**WAN - Wide Area Network**





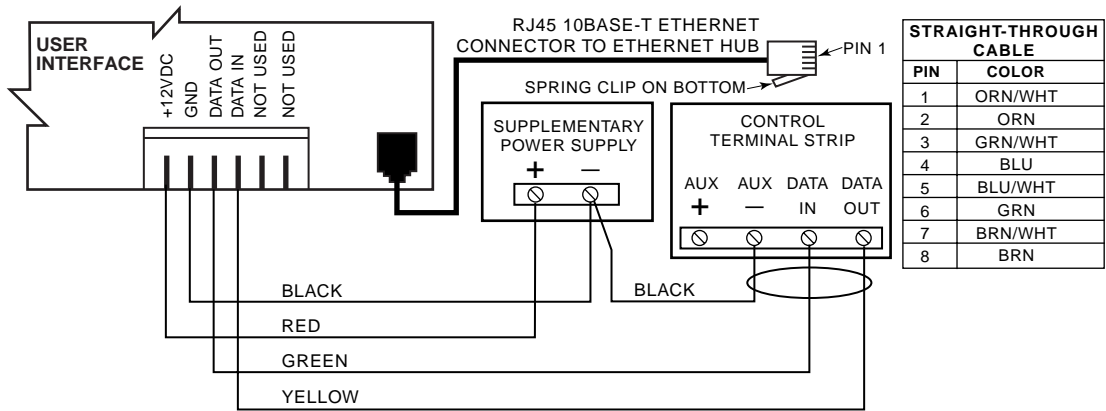

**MODEL FA8XXKP  
SUMMARY OF CONNECTIONS**

AUI-FA-SOC-V0



Use a Listed Class 2 power supply suited for the application.

### Summary of Connections Using 6-Pin Connector

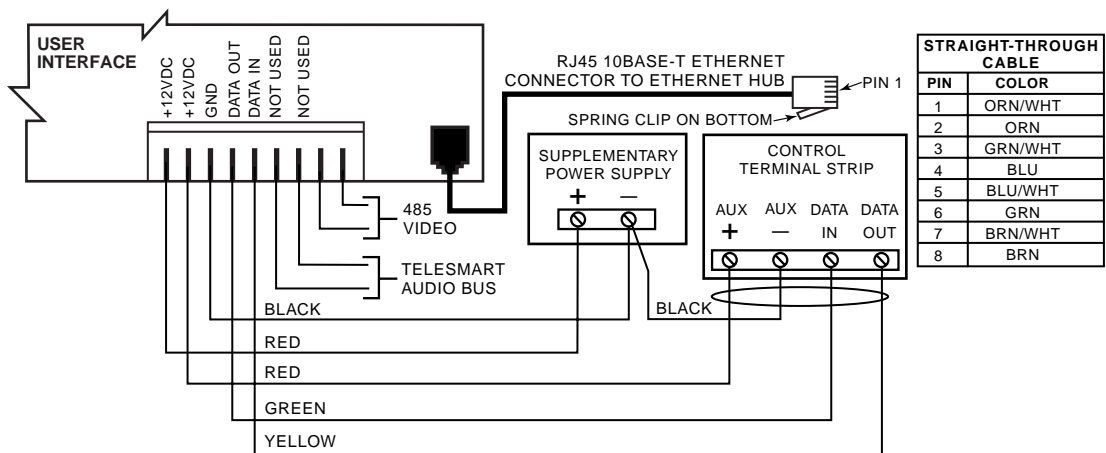

**MODELS FA8XXKP  
SUMMARY OF CONNECTIONS**

AUI-FA-SOC-V2



Use a Listed Class 2 power supply suited for the application.

### Summary of Connections Using 9-Pin Connector

### **LIMITED WARRANTY**

Pittway Corporation, and its divisions, subsidiaries and affiliates ("Seller"), 165 Eileen Way, Syosset, New York 11791, warrants its First Alert Professional products to be in conformance with its own plans and specifications and to be free from defects in materials and workmanship under normal use and service for 36 months from the date stamp control on the product or, for products not having a date stamp, for 30 months from date of original purchase unless the installation instructions or catalog sets forth a shorter period, in which case the shorter period shall apply. Seller's obligation shall be limited to repairing or replacing, at its option, free of charge for materials or labor, any product which is proved not in compliance with Seller's specifications or proves defective in materials or workmanship under normal use and service. Seller shall have no obligation under this Limited Warranty or otherwise if the product is altered or improperly repaired or serviced by anyone other than First Alert Professional factory service. For warranty service, return product transportation prepaid, to First Alert Professional Factory Service, 149 Eileen Way, Syosset, New York 11791.

THERE ARE NO WARRANTIES, EXPRESS OR IMPLIED, OF MERCHANTABILITY, OR FITNESS FOR A PARTICULAR PURPOSE OR OTHERWISE, WHICH EXTEND BEYOND THE DESCRIPTION ON THE FACE HEREOF. IN NO CASE SHALL SELLER BE LIABLE TO ANYONE FOR ANY CONSEQUENTIAL OR INCIDENTAL DAMAGES FOR BREACH OF THIS OR ANY OTHER WARRANTY, EXPRESS OR IMPLIED, OR UPON ANY OTHER BASIS OF LIABILITY WHATSOEVER, EVEN IF THE LOSS OR DAMAGE IS CAUSED BY THE SELLER'S OWN NEGLIGENCE OR FAULT.

Seller does not represent that the products it sells may not be compromised or circumvented; that the products will prevent any personal injury or property loss by burglary, robbery, fire or otherwise; or that the products will in all cases provide adequate warning or protection. Customer understands that a properly installed and maintained alarm may only reduce the risk of a burglary, robbery, fire or other events occurring without providing an alarm, but it is not insurance or a guarantee that such will not occur or that there will be no personal injury or property loss as a result. CONSEQUENTLY, SELLER SHALL HAVE NO LIABILITY FOR ANY PERSONAL INJURY, PROPERTY DAMAGE OR OTHER LOSS BASED ON A CLAIM THE PRODUCT FAILED TO GIVE WARNING. HOWEVER, IF SELLER IS HELD LIABLE, WHETHER DIRECTLY OR INDIRECTLY, FOR ANY LOSS OR DAMAGE ARISING UNDER THIS LIMITED WARRANTY OR OTHERWISE, REGARDLESS OF CAUSE OR ORIGIN, SELLER'S MAXIMUM LIABILITY SHALL NOT IN ANY CASE EXCEED THE PURCHASE PRICE OF THE PRODUCT, WHICH SHALL BE THE COMPLETE AND EXCLUSIVE REMEDY AGAINST SELLER. This warranty replaces any previous warranties and is the only warranty made by Seller on this product. No increase or alteration, written or verbal, of the obligations of this Limited Warranty is authorized.

# ***NOTE***

# ***NOTE***

# ***NOTE***

# ***NOTE***





149 Eileen Way, Syosset, NY 11791  
Copyright © 2002 PITTMAY Corporation



K5762-2V1 12/02